

August 2012

Development of a Methodology for the Quantification of Physiological Load for Soccer Players

Robert W. Wilson

University of Wisconsin-Milwaukee

Follow this and additional works at: <https://dc.uwm.edu/etd>

 Part of the [Kinesiology Commons](#), and the [Medicine and Health Sciences Commons](#)

Recommended Citation

Wilson, Robert W., "Development of a Methodology for the Quantification of Physiological Load for Soccer Players" (2012). *Theses and Dissertations*. 193.

<https://dc.uwm.edu/etd/193>

This Dissertation is brought to you for free and open access by UWM Digital Commons. It has been accepted for inclusion in Theses and Dissertations by an authorized administrator of UWM Digital Commons. For more information, please contact open-access@uwm.edu.

DEVELOPMENT OF A METHODOLOGY FOR THE QUANTIFICATION OF
PHYSIOLOGICAL LOAD FOR SOCCER PLAYERS

by

Robert W. Wilson, II

A Dissertation Submitted in
Partial Fulfillment of the
Requirements for the Degree of

Doctor of Philosophy
in Health Sciences

at

The University of Wisconsin-Milwaukee

August 2012

ABSTRACT
**DEVELOPMENT OF A METHODOLOGY FOR THE QUANTIFICATION OF
PHYSIOLOGICAL LOAD FOR SOCCER PLAYERS**

by

Robert W. Wilson, II

The University of Wisconsin-Milwaukee, 2012
Under the Supervision of Professor Ann C. Snyder.

The overall aim of this research project was to devise valid mathematical models for quantifying the physiological load (PL) of practices and competitions for female and male NCAA Division I collegiate soccer players. Data from sub-maximal and maximal effort tests were used to construct these models. After development of the physiological load quantification (PLQ) models, the validity of them occurred by comparing them to the physiological gold standard of performed work, volume of oxygen consumed ($\dot{V}O_2$). Last, comparisons of the scores from the PLQ models to the PL scores from the previous models occurred. In combination these three studies have produced models which are physiologically realistic, have a very strong relationship with the gold standard of work performed and are unique when compared to the models previously presented in the research literature for the assessment of PL.

© Copyright by Robert W. Wilson, II, 2012
All Rights Reserved

DEDICATION

First, I apologise to those who I forget to mention. The path to this point has been long and has wound halfway around the globe both literally and figuratively.

Thanks must first go to my parents, not just for the fact that this is where I got my start but also for the fact that they realized that someone of my size would have met an early demise playing American football and so “allowed” me to play the real game of association football, also know as soccer. The game has brought me many joys and frustrations, has taken me to many places and opened doors to people and experiences that I may not have had otherwise. So thank you, Mother and Father for introducing me to the world through the world of football.

I must also recognize Mr. David Anderson, my high school guidance counselor. When I was 14 years old, he introduced me to coaching soccer. I remember fondly the days he would take me to Bolingbrook in his rusted old Volvo station wagon and then back to Lisle. That was a team of youngsters that wanted to have fun and play and learn about soccer.

There were many coaches, like Mr. John Sweeney at Marquette University, Mr. Tony DiCicco who was the coach of the U.S. Women’s Soccer team and Mr. Paul Cacolice who was the first Certified Strength and Conditioning Specialist that I knew, from whom I learned much over the years. However, there are two coaches to whom I owe significant debts, they are Mr. Al Harris and Mr. Dave Randall. Coach Harris taught me how to see the game through a critical eye. While I had kept track of what I did with my players before my time with him, it was after working with him that I realized the importance of not just collecting but analyzing the data – that was probably the start of

my journey to becoming a sports scientist. Coach Randall is the baseball coach and athletic director at Waubensee Community College (WCC). He gave me a chance to be, and more importantly, to “feel” like a real coach. He taught me that coaching is building a relationship with players and helping them to see their talents. It was during my coaching career at WCC, that the genesis of this dissertation started. The day after a game which went to penalty kicks, which meant that the game lasted 120 minutes by the referees watch, I arrived at practice about 10 minutes late to see the team engaged in a half-field scrimmage at full speed. I was confused. If they had this much energy now, why weren't they able to push themselves that little bit harder the night before and to win the game in regulation or during one of the two golden-goal overtime periods? If they were truly exhausted by the effort they had put forth, then how much can I push them during practices before they start to get injured and then can't play at the end of the season? These questions about the ability to recover and the “correct” amount of training load are still not very well understood. This dissertation and my previous research into the physiological load experienced by athletes is directed at trying to answer these questions.

In the Fall of 2002 I began taking classes toward my Master in Science degree in Kinesiology at the University of Wisconsin – Milwaukee. It was during one of the HMS700 classes that I was introduced to Dr. Ann C. Snyder and the work that she had conducted to investigate the relationship between lactate threshold, maximal lactate steady-state running, and tissue oxygenation and de-oxygenation. It was that work and the booklet published by Mr. Ken Pollard that led me to working with Dr. Snyder. I have had the honor to work with her in the Human Performance Lab at UW-M in an official

capacity over the last 8 years. She has helped me to learn how to do and how not to do things, how to be polite and kind in awkward situations, how to conduct research, how to include others in the work that we have done, and how to smile. I appreciate all that she has taught me. Thank you.

I would like to thank the other student members of the Human Performance Lab, especially Ms. Grace Brown, Ms. Julie Pfeiffer and Ms. Leeanna Kligis for their support and assistance, and Mr. Brian P. Edlbeck for his willingness to listen to me expound and then ask the basic questions that kept me on track. Also, I need to thank the staff of the R2D2 Lab, Dr.s Rochelle Mendonca, Goeran Fiedler, Sandeep Golpalakrishnan, Pamla Boulton, JoAnne Graham and Roger Smith, Mr. Dennis Tomashek and Mrs.s Lillian Folk, Patricia Hayes, Desere Liddell, Sheryl Slocum, and Wendy Pribbanow for the discussions on numerous topics, and their support, encouragement, firmness and friendship during this journey.

To the soccer players who took part in this endeavor, I express my appreciation and gratitude for your time and willingness to participate. Thank you, also to all of the players who I have coached for you too have led me to this work.

To my dissertation committee members, while this work could not have been done without your approval and guidance, it is your expertise in your disciplines and willingness to steer me in the right direction that has made this experience enjoyable to me, I hope you feel the same way. Thank you. I need to thank Dr. Bruce Wade for reaching out to the Human Movement Sciences Department. That e-mail led to my collaboration with Mr. Tom Goepfinger, who helped to ensure that the models presented herein are not only realistic but mathematically appropriate and accurate.

Lastly, I need to thank my wife Beth, my children Abby and Bobby, my mother-in-law Mrs. Kristine Beaster and my aunt-in-law Mrs. Evvanne McCulloch. As I have said often, “My daughter put me into my Masters (in 2002) and my son put me into my PhD (in 2007).” While there is some truth and some coincidence in that statement, there is no doubt that I could not and would not have pursued these advanced degrees without the support of my wife and her mother and aunt. What started as a brief comment to my wife on College Avenue in Palmerston North, New Zealand in 2001 has led us to this point. To my wife, I appreciate the time that you have given me to stay on campus until the wee hours and the mornings that you have left me to sleep in after my long-nights. Thank you for allowing me to go to conferences to present my research and network while you watched the kids with the help from your mother and aunt. [To all of you who read this and contemplate earning an advanced degree with a family, I wish you luck because you do not have my wife in your corner – best of luck finding someone as good as she is]. To my beautiful children, “Daddy is done with his dissertation!!”

With many thanks and enduring gratitude,

Robert W. Wilson, II, MS, CSCS*D
AOP Fellow
Doctoral Candidate, College of Health Sciences
Human Performance Laboratory
University of Wisconsin – Milwaukee

TABLE OF CONTENTS

LIST OF FIGURES	x
LIST OF TABLES	xiii
LIST OF NOMENCLATURE AND ABBREVIATIONS	xv
ACKNOWLEDGEMENTS	xviii
SECTION 1: Introduction	1
Statement of Problem	2
Statement of Purpose	3
Significance of these studies	4
Review of Literature	5
Stress	5
Physical activity	7
Sports	11
Validity of heart rate	30
Summary	33
Statement of Purpose	33
Aims of the Study	34
Hypotheses	34
SECTION 2: Methodology	36
Study design	37
Aims and Hypotheses	40
Overall aim	40
Specific aims and hypotheses	40

Timeline	43
Equipment	45
Variables	50
Physiological Tests	52
Methods of Analyses	58
SECTION 3: Studies	61
Study 1: Assessment of Multiple Physiological Variables for Use in the Quantification of Physiological Load	62
Study 2: Validation of Models for the Determination of the Physiological Load of Collegiate Soccer Players	95
Study 3: Comparison of Models for the determination of Physiological Load in NCAA DI Soccer Athletes	118
SECTION 4: Discussion	138
SECTION 5: Conclusion	146
SECTION 6: Future directions	148
SECTION 7: References	150
Appendix A: Institutional Review Board at UW–M Approval Documents - Protocol 07_02_172 (2010)	161
Appendix B: Informed Consent Document and Health History Questionnaire for Protocol 07_02_172 (2010)	167
Appendix C: Informed Consent Document and Health History Questionnaire for Protocol 07_02_172 (2011)	177
Appendix D: Permissions to use Copyrighted materials	187

LIST OF FIGURES

SECTION 1: Introduction

Figure 1.1	The General Adaptation Syndrome	6
Figure 1.2	Adaptation of Selye's General Adaptation Syndrome to 3 exercise training intensities (i.e., 3 levels of stress)	12
Figure 1.3	Theoretical adaptations to different workloads in a periodized model	12
Figure 1.4	Banister and colleagues initial model of factors affecting athletic performance	15
Figure 1.5	The simplified model for the prediction of performance levels based on endurance training	16

SECTION 3: Studies

Study 1: Assessment of Multiple Physiological Variables for Use in the Quantification of Physiological Load

Figure 3.1.1a.	Scatterplot of %HRR data against [HLA] data from sub-maximal and maximal effort tests	74
Figure 3.1.1b.	Scatterplot of HR data against [HLA] data from sub-maximal and maximal effort tests	75
Figure 3.1.1c.	Scatterplot of %HR _{max} data against [HLA] data from sub-maximal and maximal effort tests	75
Figure 3.1.1d.	Scatterplot of VR data against [HLA] data from sub-maximal and maximal effort tests	76
Figure 3.1.1e.	Scatterplot of ACT data against [HLA] data from sub-maximal and maximal effort tests	76
Figure 3.1.1f.	Scatterplot of PkA data against [HLA] data from sub-maximal and maximal effort tests	77
Figure 3.1.1g.	Scatterplot of ST data against [HLA] data from sub-maximal and maximal effort tests	77
Figure 3.1.1h.	Scatterplot of BP data against [HLA] data from sub-maximal and maximal effort tests	78

LIST OF FIGURES (continued)

Figure 3.1.2a. [HLA] values expressed against %HRR for the female players – the $p[HLA]_{ws3p}$ curve	80
Figure 3.1.2b. [HLA] values expressed against %HRR for the female players – the $p[HLA]_{wsi}$ curve	81
Figure 3.1.2c. [HLA] values expressed against %HRR for the male players – the $p[HLA]_{MSi}$ curve	81
Figure 3.1.3. Scatter plot of PLQ_{WS} scores against PLQ_{MS} scores	84
Study 2: Validation of Model for Determination of the Physiological Load of Collegiate Soccer Players	
Figure 3.2.1a. Scatterplot of PLQ against $\dot{V}O_2\text{-abs}$ for female and male participants	105
Figure 3.2.1b. Scatterplot of PLQ against $\dot{V}O_2\text{-rel}$ for female and male participants	105
Figure 3.2.1c. Scatterplot of PLQ against $\% \dot{V}O_{2max}$ for female and male participants	106
Figure 3.2.1d. Scatterplot of PLQ against $\% \dot{V}O_2R$ for female and male participants	106
Figure 3.2.2a. Bland-Altman Plot $\dot{V}O_2\text{-abs-msr}$ and $\dot{V}O_2\text{-abs-pred}$ from the group $\dot{V}O_2\text{-abs}$ curves for female participants	107
Figure 3.2.2b. Bland-Altman Plot $\dot{V}O_2\text{-rel-msr}$ and $\dot{V}O_2\text{-rel-pred}$ from the group $\dot{V}O_2\text{-rel}$ curve for female participants	107
Figure 3.2.3a. Bland-Altman Plot $\dot{V}O_2\text{-abs-msr}$ and $\dot{V}O_2\text{-abs-pred}$ from the group $\dot{V}O_2\text{-abs}$ curve for male participants	108
Figure 3.2.3b. Bland-Altman Plot $\dot{V}O_2\text{-rel-msr}$ and $\dot{V}O_2\text{-rel-pred}$ from the group $\dot{V}O_2\text{-rel}$ curve for male participants	108
Figure 3.2.3c. Bland-Altman Plot $\% \dot{V}O_{2max}\text{-msr}$ and $\% \dot{V}O_{2max}\text{-pred}$ from the group $\% \dot{V}O_{2max}$ curve for male participants	109

LIST OF FIGURES (continued)

Figure 3.2.3d. Bland-Altman Plot $\% \dot{V}O_2R$ -msr and $\% \dot{V}O_2R$ -pred from the group $\% \dot{V}O_2R$ curve for male participants	109
Figure 3.2.4a. PLQ scores against $\dot{V}O_2$ -abs curves from each female participant's sub-maximal effort tests	112
Figure 3.2.4b. PLQ scores against $\dot{V}O_2$ -abs curves from each male participant's sub-maximal effort tests	113
Study 3: Comparison of Models for the determination of Physiological Load in NCAA DI Soccer Athletes	
Figure 3.3.1. Mean PL scores for female players	129
Figure 3.3.2. Mean PL scores for male players	129
Figure 3.3.3a. Line graph of scores from the PLQ_{WS} and $TRIMP_{Millet}$ models	132
Figure 3.3.3b. Line graph of scores from the PLQ_{WS} and $TRIMP_{fit}$ models	133

LIST OF TABLES

SECTION 1: Introduction

Table 1.1.	Borg criterion referenced 10-point rating of perceived exertion scale	9
Table 1.2	Training load/ workload methodologies	17
Table 1.3.	Mean-intensity PL methodologies	19
Table 1.4.	3-intensity zone PL methodologies	22
Table 1.5.	5-intensity zone PL methodologies	25
Table 1.6.	Continuous-tracking PL methodologies	29

SECTION 2: Methods

Table 2.1.	Modified Borg criterion referenced 10-point rating of perceived exertion scale (mCR10)	47
Table 2.2.	Sub-maximal effort protocol – variable start	55
Table 2.3.	Sub-maximal effort protocol – standardized start	55
Table 2.4.	Human Performance Laboratory modified-Conconi maximal effort treadmill protocol (HMC10)	57
Table 2.5.	Human Performance Laboratory modified-Conconi maximal effort treadmill protocol (HMC11)	57
Table 2.6.	Pearson product-moment correlation and coefficient of determination interpretation	59

SECTION 3: Studies

Study 1: Assessment of Multiple Physiological Variables for Use in the Quantification of Physiological Load

Table 3.1.1.	Demographic data for players used to generate PLQ_{WS} and PLQ_{MS}	67
Table 3.1.2.	Sampling and reporting information for Zephyr Bioharness variables	70
Table 3.1.3	HR_{rest} for 20-29 year old individuals and HR_{low} for study participants	71

LIST OF TABLES (continued)

Table 3.1.4.	Sub-maximal effort treadmill protocols	72
Table 3.1.5.	Human Performance Laboratory modified-Conconi maximal effort treadmill protocols (HMC10 and HMC11)	73
Table 3.1.6.	Best-fit multivariate linear regression equations	79
Table 3.1.7.	Best-fit univariate PLQ_{WS} model for each non-linear regression	79
Table 3.1.8.	Demographic data for players used in the comparison of the PLQ_{WS} and PLQ_{MS} models	82
Table 3.1.9.	Scores generated from the PLQ_{WS} and PLQ_{MS} models	83
Study 2: Validation of Model for Determination of the Physiological Load of Collegiate Soccer Players		
Table 3.2.1.	Sub-maximal effort treadmill protocols	101
Table 3.2.2.	Human Performance Laboratory modified conconi maximal effort treadmill protocols	101
Table 3.2.3.	Pearson product-moment correlation coefficients between the PLQ_{WS} model scores and measures of $\dot{V}O_2$	104
Table 3.2.4.	Pearson product-moment correlation coefficients between the PLQ_{MS} model scores and measures of $\dot{V}O_2$	104
Study 3: Comparison of Models for the determination of Physiological Load in NCAA DI Soccer Athletes		
Table 3.3.1.	Formulae for previous PL models	127
Table 3.3.2.	Correlations between PLQ_{WS} and PLQ_{MS} and other PL scores	130

LIST OF NOMENCLATURE AND ABBREVIATIONS

ACT	activity (from Zephyr Bioharness System)
au	arbitrary unit
beats • min ⁻¹ <i>or</i> bpm	beats per minute
breaths • min ⁻¹	breaths per minute
BP	body position (from Zephyr Bioharness System)
C	degrees Celsius
g	gravitational force
[HLa]	concentration of lactate in whole blood
HMC10	Human Performance Laboratory modified conconi maximal effort test designed in 2010
HMC11	Human Performance Laboratory modified conconi maximal effort test designed in 2011
HR	heart rate
HR _{max}	maximal heart rate
%HR _{max}	percentage of maximal heart rate, expressed as a decimal
HRR	heart rate reserve
%HRR	percentage of heart rate reserve, expressed as a decimal
%HRR _i	individual percent of heart rate reserve values, expressed as a decimal
Hz	Hertz in cycles per minute
HZT	Heart Zones Training methodology
ICC	Intraclass Correlation coefficient
kg	kilogram
kg • m ⁻²	kilogram per meter squared
km • h ⁻¹	kilometers per hour
l	liter
l • min ⁻¹	liter per minute
max	maximum/ maximal
m	meter
mean	average
ml • kg ⁻¹ • min ⁻¹	milliliter per kilogram per minute
mi	miles
mi • h ⁻¹ <i>or</i> mph	miles per hour
min	minimum/ minimal, or minute
n	number of
PkA	peak acceleration (from Zephyr Bioharness System)
PL	physiological load
PLQ	physiological load quantification
PLQ _{MS}	physiological load quantification model for male soccer players
PLQ _{WS}	physiological load quantification model for female soccer players
r	Pearson's Product-moment correlation coefficient
RMSE	root of the mean-square error
RPE	rating of perceived exertion

LIST OF NOMENCLATURE AND ABBREVIATIONS (continued)

s	standard deviation
sec	second
SM	sub-maximal
sr	sampling rate of HR monitor (i.e., the number of values reported in 1 min)
sRPE	session RPE
ST	skin temperature (from Zephyr Bioharness System)
TRIMP	training impulse
TRIMP _{fit}	TRIMP fit model
TRIMP _i	TRIMP individual model
TRIMP _{Lucia}	Lucia's TRIMP model
TRIMP _{Millet}	Millet's TRIMP model
TRIMP _{mod}	Stagno, Thatcher and vanSomeren's Modified TRIMP model
TRIMP _{Wood}	Wood's TRIMP model
TRIMP ₈₀	Banister and colleagues' 1980 TRIMP model
TRIMP ₈₆	Banister and colleagues' 1986 TRIMP model
VMU	Vector magnitude units
$\dot{V}O_2$	volume of oxygen consumed in a minute
$\dot{V}O_{2-abs}$	volume of oxygen consumed in a minute expressed in absolute terms
$\dot{V}O_{2-abs-msr}$	measured volume of oxygen consumed in a minute expressed in absolute terms
$\dot{V}O_{2-abs-pred}$	predicted volume of oxygen consumed in a minute expressed in absolute terms
$\dot{V}O_{2max}$	maximal volume of oxygen consumed in a minute
$\% \dot{V}O_{2max}$	volume of oxygen consumed in a minute expressed as a percentage of the maximal amount of oxygen consumed, expressed as a decimal
$\% \dot{V}O_{2max-msr}$	measured volume of oxygen consumed in a minute expressed as a percentage of the maximal amount of oxygen consumed, expressed as a decimal
$\% \dot{V}O_{2max-pred}$	predicted volume of oxygen consumed in a minute expressed as a percentage of the maximal amount of oxygen consumed, expressed as a decimal
$\dot{V}O_{2R}$	oxygen uptake reserve
$\% \dot{V}O_{2R}$	volume of oxygen consumed in a minute as expressed as a percentage of the oxygen uptake reserve, expressed as a decimal
$\% \dot{V}O_{2R-msr}$	measured volume of oxygen consumed in a minute as expressed as a percentage of the oxygen uptake reserve, expressed as a decimal

LIST OF NOMENCLATURE AND ABBREVIATIONS (continued)

$\% \dot{V}O_2R\text{-pred}$	predicted volume of oxygen consumed in a minute as expressed as a percentage of the oxygen uptake reserve, expressed as a decimal
$\dot{V}O_2\text{-rel}$	volume of oxygen consumed in a minute expressed in relative terms
$\dot{V}O_2\text{-rel-msr}$	measured volume of oxygen consumed in a minute expressed in absolute terms
$\dot{V}O_2\text{-rel-pred}$	predicted volume of oxygen consumed in a minute expressed in absolute terms
VR	ventilation rate (from Zephyr Bioharness System)
yr	year
°	degrees
%	percent

ACKNOWLEDGEMENTS

Permission to reprint the images in the following figures in SECTION 2: Introduction has been obtained as expressed:

- Figure 4. Banister and colleagues initial model of factors affecting athletic performance (18) © 1982, from Physiological Testing of the Elite Athlete. Used with permission from the Canadian Society for Exercise Physiology.
- Figure 5. The simplified model for the prediction of performance levels based on endurance training. (115) Reproduced with permission from the American Physiological Society.

Partial funding for this research was provided by Zephyr Technology, Inc.

EPIGRAPH

'Some people believe football is a matter of life and death, I am very disappointed with that attitude. I can assure you it is much, much more important than that.'

– Bill Shankly, Manager of Liverpool Football Club (1959-1974)

Ago et praesto igitur sum.

SECTION 1: Introduction

Statement of Problem

Athletes engage in training sessions, a form of stress, on a regular basis. This stress elicits a strain and then a response in both general and specific ways. Training sessions incorporate activities of varying intensities on a regular basis to achieve the desired performance level. Over time, too little stimulus will result in no performance gains or in detraining, where performance capabilities are lost. Likewise, too much stimulus can lead to staleness or overtraining. Both of these latter conditions require an unintended period of rest which necessitates a reduction in or cessation of training to allow the individual to recover to the point where they can start training again.

Systems exist to quantify the workload, also referred to as training load (TL) in sports, that an athlete engages in on a daily and weekly basis. These workloads can be regulated through the creation of training plans. However, training plans typically do not indicate the physiological load (PL), or strain, experienced by the athletes; rather they only present the workload, or stress, that is planned.

Thus, methodologies for determining and quantifying the PL have been created. Most of the methodologies rely on a transformed form of heart rate (HR) as their measure of intensity (i.e., strain). The resulting PL scores have been generated in such a way that they can be cumulated, so the PL over a specified period of time can be expressed. Only one of the models has been constructed to be used with a team, and that model employs a zonal approach which may exclude data collected during a practice or competition session. Also, only one of these models has been validated against a gold-standard variable of work, like oxygen uptake ($\dot{V}O_2$).

While these methodologies seem reasonable, recent technological advances now allow for other variables to be collected in a field setting. Therefore, there is a need to determine if any of these newly available measures can enhance the assessment of PL in a field setting.

Previous research has called for a methodology for assessing the PL of training and competitive sessions. It has been requested that the technique be able to recognize “different intensity levels within a training session” (37) and provide a better understanding of the relationship between the magnitude and type of the training stimulus (54). It is intended that this new methodology will be able to satisfy these perceived needs and therefore allow coaches and researchers to track and correlate the relationship between the TL and the physiological response. This may allow coaches and sports scientists to gain a better understanding of the nature of the resulting training adaptations.

Statement of Purpose

Technological advances over the past decade in the areas of electronic component miniaturization and data storage now allow data to be collected and stored in a field (or non-laboratory) setting. Some recently developed devices allow for the assessment of multiple physiological and non-physiological variables, which may prove useful in understanding the interaction between physiological responses and movement characteristics in a field setting.

Thus, the purposes of this dissertation were to construct model(s) to be used in the quantification of PL for players on National Collegiate Athletic Association (NCAA) Division I (DI) soccer teams during training and competitions (i.e., field settings) using recently developed technology, to assess the internal validity of the resulting

quantification model and to assess the degree of difference and similarity between the scores of these new model(s) and the previously devised model(s).

Significance of these studies

At present, the majority of the model(s) for quantifying PL in a field setting rely on a single collected value (typically HR). Study 1 assessed the efficacy of multiple field-obtainable variables (i.e., HR, percent of maximal HR ($\%HR_{max}$), percent of HR reserve ($\%HRR$), ventilation rate (VR), skin temperature (ST), activity (ACT), peak acceleration (PkA), and posture (BP)) for use in the quantification of the PL experienced during practice and competition sessions of all members of the soccer teams, including those players who were not able to participate in the testing. Also, current PL quantification schemes have not been validated against a gold-standard measure of workload (i.e., $\dot{V}O_2$). The second study assessed the internal validity of the new models against $\dot{V}O_2$ data. Previous studies which have compared existing PL models only assessed the relationship or difference between the PL scores of a few models. The third study compared the PL scores from the new models and the scores from all other known models.

Review of Literature

Stress

Stress is a fundamental part of life. When a stress is put upon our bodies, whether through psychological or physical means, we either cope with or surrender to the cascade of deleterious effects of the acute assault. If we cope and thus survive, the body readies itself for subsequent assaults as best it can through adaptations from the level of the cell to the system.

The theoretical relationship between stress, strain and adaptation was presented in Dr. Hans Selye's General Adaptation Syndrome (133). The model proposed a dose-response relationship between the stress (a stimulus which challenges the body) and the resulting strain (the physiological response)*. The General Adaptation Syndrome is comprised of the alarm reaction, the stage of resistance and the exhaustion stage (Figure 1.1). The alarm reaction, denoted by the downward slope of the stasis line in Figure 1.1, is induced when an organism encounters a stress. The objective of the body is to invoke a response that will slow and halt the strain, which is represented by the nadir of the stasis line (Figure 1.1). In response, the organism enters the stage of resistance and responds in three ways. Initially, there is a non-specific response to the stress; this is a response that is the same regardless of the type of stress encountered (134). The specific response to the stress attempts to protect the affected tissues and combat the stress in the local

* In *The Stress of Life* (1978), Dr. Selye acknowledged the lack of integrity between his terminology and that of the field of physics. In physics, "stress" refers to the load or force that is exerted, and "strain" is the resulting internal response to the load or force that is being applied. Therefore, in accordance with this revised stance, "stress" will refer to the external load placed upon an individual and "strain" will refer to the internal physiological response.

environment. The internal and systemic responses may inhibit or terminate the protective response and thus surrender the affected tissue. The ability to resist the stress and the adaptation to withstand a similar assault depends on the balance of these three reactions.

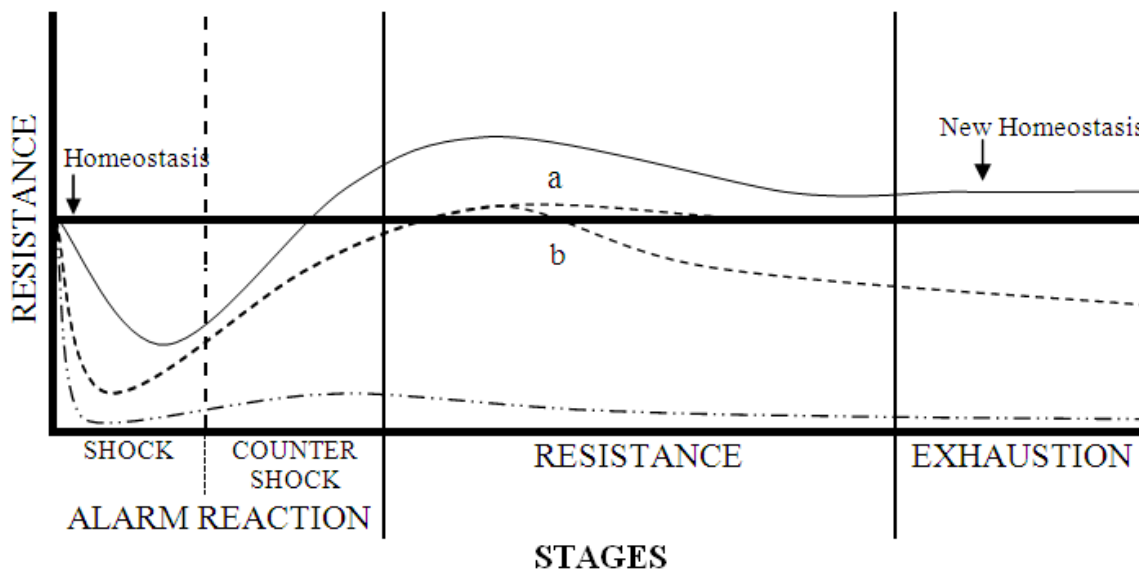

- A stress that induces a moderate level of strain which is able to be overcome and induces a super-compensation.
- - - A stress that induces a high and immediate level of strain which requires a longer period of recovery (a return to homeostasis). The “a” segment indicates that the stress is managed and homeostasis is reached. The “b” segment indicates the organism cannot resist (i.e., negate the effects of) the stress and homeostasis is not attainable and thus exhaustion ensues.
- This line indicates a stress that induces a high and immediate level of strain that is greater than the counter shock and resistance capacities of the organism. Thus, homeostasis is not reached and the organism (either in whole or part) is in threat of death.

Figure 1.1. The General Adaptation Syndrome (This model is a combination of several sources (132, 133, 135).

If the protective responses are able to overcome the stress given the organism's current level of capacity, then a local (or system specific) adaptation occurs. These adaptations induce a protective effect in which the organism has a greater capacity to manage the same kind of threat. This increased capacity is referred to as “super-compensation.” This adaptive response is seen in the immune response from a vaccine, where an organism is

subjected to a compromised version of a virus (the stress) and is able to develop the antibodies necessary to combat that virus. However, if the strain is too great, either by acute magnitude or chronic exposure, the organism cannot regain homeostasis and enters the stage of exhaustion. In this phase, the damage to the organism presents a lethal threat to the cell, the tissue, the systems, or the organism itself.

Therefore, it is important for the survival of the organism that stresses produce a level of strain that can be overcome. With recovery, the potential for super-compensation also exists.

Physical activity

Physical activity has been described as “any bodily movement produced by skeletal muscles that results in energy expenditure” (35). Physical activity has been seen as a source of stress to both the local (i.e., muscle) and systemic (i.e., cardiovascular) environments. In response to engaging in physical activity there can be increases in oxygen consumption and carbon dioxide production by working muscles, HR, cardiac output, breathing (ventilation) rate and sweat rate. The level of response is proportional to the amount of strain combined.

In accordance with the GAS model, if an individual engages in regular moderate physical activity they can induce an increased level of fitness in the systems that are challenged. Thus the resulting increase in fitness level as indicated by the ability to perform the same absolute workload (i.e., stress) at a lower physiological cost (i.e., strain), can be seen as what Selye called “super-compensation.”

Moderate-intensity exercise

Exercise is “a subset of physical activity that is planned, structured, and repetitive and has as a final or an intermediate objective the improvement or maintenance of physical fitness” (35). The greatest health benefits come from strategies that promote regular physical activity (8, 101, 121, 136). The benefits are realized psychologically, physically and physiologically. Some of the benefits from engaging in regular moderate-intensity physical activity are enhanced mood (89), reduced depression symptoms (38, 64, 114), reduced depression and anxiety disorders (123, 141, 148), reduced risk of developing high blood pressure (148), some cancers (23, 104) and developing diabetes (148), and a decreased risk of premature death and death (148). An extensive review of exercise recommendations and benefits of exercise has been written by Warburton and colleagues (151).

Organizations such as the American College of Sports Medicine (ACSM), the World Health Organization (WHO) and the Centers for Disease Control and Prevention (CDC) have advocated regular moderate-intensity exercise in order to attain health benefits from exercising. The ACSM states that people should engage in moderate-intensity exercise three to five times each week for 20 – 60 minutes at a time (6). The ACSM classifies moderate-intensity exercise as 40 – 59 % of $\dot{V}O_2$ reserve or HR reserve ($\% \dot{V}O_{2R}$, and $\%HRR$, respectively), or 55 – 69 % of maximal HR ($\%HR_{max}$), or a Rating of Perceived Exertion score 12 - 13 on the Borg Rating of Perceived Exertion Scale (6). The WHO (158) and the CDC (36) guidelines state that adults should engage in as “least 150 minutes (2 hours and 30 minutes) a week of moderate-intensity.” The WHO and CDC define moderate-intensity as the intensity that increased $\dot{V}O_2$ by “3.0 to 5.9 times the

intensity of rest” in absolute terms, or in relative terms a 5 or 6 on the Borg Criterion-Reference 10 point (CR10) Rating of Perceived Exertion (RPE) scale (28) (Table 1.1).

Table 1.1. Borg criterion referenced 10-point rating of perceived exertion scale (27)

0.0	Nothing at all	“No P”
0.3		
0.5	Extremely weak	Just noticeable
1.0	Very weak	
1.5		
2.0	Weak	Light
2.5		
3.0	Moderate	
4.0		
5.0	Strong	Heavy
6.0		
7.0	Very Strong	
8.0		
9.0		
10.0	Extremely strong	“Max P”
↖		
●	Absolute maximum	Highest possible

Vigorous-intensity exercise

The WHO (158) and the CDC (36) guidelines also advocate 75 minutes per week of vigorous-intensity aerobic physical activity in lieu of their moderate intensity physical activity recommendations. Vigorous-intensity physical activity is defined in absolute terms as an activity “performed at 6.0 or more times the intensity of rest for adults” (158) or an CR10 RPE score of 7 or 8 on the CR10 scale (36, 158).

Researchers have compared the vigorous- and moderate-intensity exercise and have found similar beneficial effects, such as an association with reduction in state anxiety (67, 110, 123), and improvements in performance capacity (129). Working out at a vigorous-intensity has been shown to result in greater performance gains than exercising at a

moderate-intensity (129). Also, Bartlett and colleagues (20) found that their participants enjoyed vigorous-intensity exercise more than moderate-intensity exercise, which may affect adherence rates.

Negative effects of exercise

Research studies support the assertion that too much exercise can produce negative effects. An increase in the amount of training has been associated with increases in mood disturbances in a dose-response pattern (124). Too much training (i.e., strain) can also lead to staleness and eventually overtraining. Staleness has been defined as “a state in which the athlete has difficulty maintaining standard training regimens and can no longer achieve previous performance results (i.e., performance decline)” (66). Overtraining has been defined as “a long-lasting performance incompetence due to an imbalance of sport-specific and non-sport-specific stressors and recovery with atypical cellular adaptations and responses.” (138). Therefore, staleness may be seen as a precursor to overtraining. This dose-response relationship between training and staleness has been observed in swimmers (111, 113), speed skaters (65), rowers (125), and wrestlers (111). Stale athletes have been known to exhibit sleep disturbances and emotional distress (112), and possibly clinical depression (111). Morgan and colleagues (113) found that 64% and 60% of elite male and female long distance runners, respectively, have been stale at some point in their training history. The only known cure for staleness is “rest, and possibly a cessation of training for several weeks” (124) or longer as the effects of staleness can persist for as long as six months (19). Due to the greater severity of overtraining, athletes may require longer periods of rest and recovery before they can start to train again.

Vigorous-intensity exercise has also been associated with increases in illness (7, 50), and injury (7).

Sports

Athletes engage in purposeful bouts of exercise (i.e., training) which combine activities of varying (from low- to vigorous-) intensities on a regular basis to achieve the desired performance level, with the understanding that vigorous-intensity activities are necessary in order to obtain high performance capabilities (83). Selye's GAS model was adopted by American weightlifters as a model for understanding the relationship between training loads and training adaptations. It was advocated that athletes should invoke an alarm reaction and the resistance phase but not induce the exhaustion phase as that would be counterproductive (60). Combined with a recovery/ rest period, bouts of different intensities can be scheduled to lead to adaptations (i.e., super-compensation). The GAS model has been redrawn to illustrate the potential outcomes (Figure 1.2).

The principles and stages of the GAS model are woven into the tenets and precepts of periodization (Figure 1.3). Periodization is the planning of the distribution of training stress; that is the combination of different training volumes and intensities, over a prescribed period of time. By varying the training stress, coaches and trainers are able to focus their attention on the development of specific adaptations (such as strength and agility) and abilities (such as psychological and technical skills). Sports scientists and coaches in the Soviet Union and Eastern Block countries worked extensively to devise periodized training programs for their athletes. Most of these complex programs were designed to be implemented over a four-year period to prepare athletes for the Olympic Games. Today, periodized plans are shorter and generally more simple; focusing

primarily on the physical training and covering only a one year period.

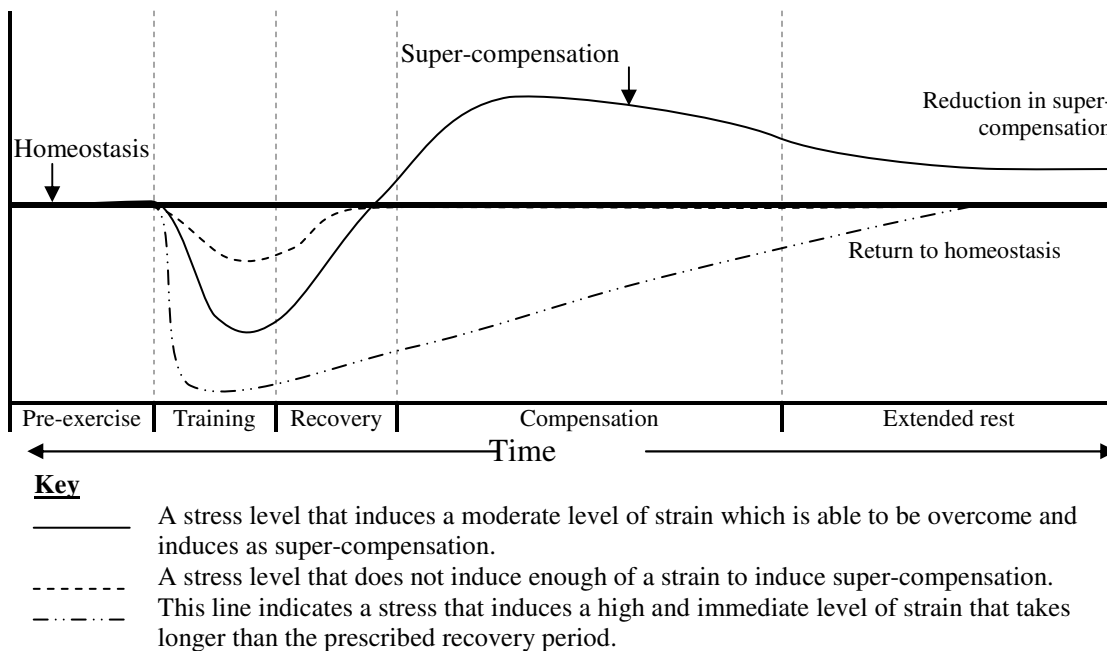

Figure 1.2. Adaptation of Selye's General Adaptation Syndrome to 3 exercise training intensities (i.e., 3 levels of stress).

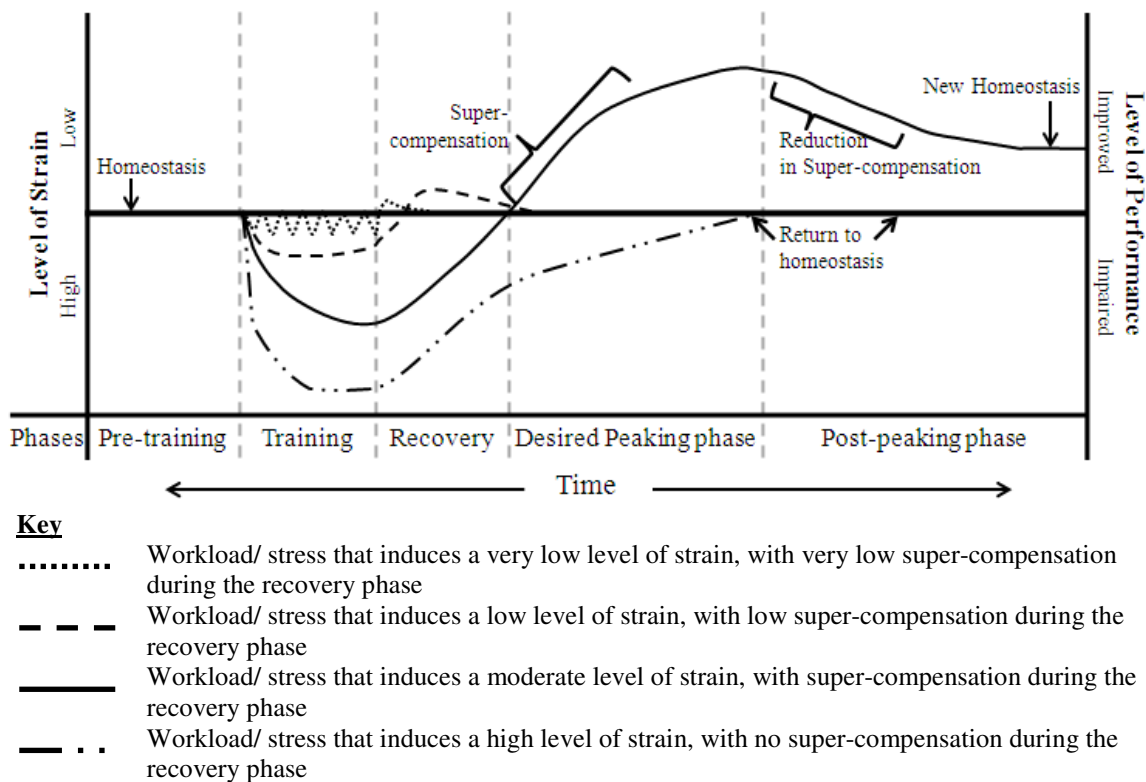

Figure 1.3. Theoretical adaptations to four different workloads in a periodized model.

One of the principle goals of a periodized program is to have an athlete peak at a desired time, usually a specific sporting event (e.g., the championship event) (25, 26). The other principle goal of periodization is to balance the distribution of training stress to produce overreaching but prevent the development of staleness and overtraining during a training period (25, 26). Like staleness and overtraining, overreaching is signified by a period of diminished capabilities (126). However, overreaching is a planned physiological state. After being achieved, it is followed by a period of rest so the athlete may recover and then (hopefully) super-compensate. Overtraining and staleness are unintended results of too much training stress, where the time required for recovery is not scheduled in the program. This additional recovery time is a disruption of the training program, which may affect the ability to peak at the desired time.

When a coach plans a training sessions, the training load (or workload) is prescribed in either volume or intensity terms. Typical volume metrics are the number of miles run in a week, the number of kilometers swum in a week, or the amount of weight lifted (the number of sets multiplied by the number of repetitions multiplied by the amount of weight lifted) in a session. Typical intensity measures are distance run at a pace, HR (target HR, %HRR, or %HR_{max}) or $\dot{V}O_2$ ($\dot{V}O_2$, % $\dot{V}O_2R$ or % $\dot{V}O_{2max}$) values, or percent of one repetition maximum (1RM) lifted. Thus, periodization is a way to manage the training load (stress) and not a mechanism for determining and assessing the individual's response or the PL (strain).

Sports also present temporal and performance constraints on the competitors. If someone who engages in regular exercise becomes overreached, or even overtrained, they can cease exercising in order to recover and experience limited repercussions.

However, an athlete's training schedule (if designed properly) will lead them to peak at the correct time, usually a competition event. Failure to peak at this point due to overtraining can be personally devastating for the athlete and may have financial consequences, especially for sponsored athletes (i.e., Olympians and university student-athletes) and professional athletes and teams. Therefore, a system which can reliably and validly track the physiological responses of and resulting strain on athletes over time is needed.

Predicting performance

Banister and colleagues (15) created a model to predict competitive performance (Figure 1.4). This model focused on the factors that could affect performance and therefore tried to integrate factors such as training, physical capabilities, skill level, psychological skills and state, as well as fatigue. The model was constructed on the premises that an exercise session induces a level of fatigue and that the fatigue level is mediated by an individual's level of fitness. This model was later simplified (115) and focused on the levels of fitness and fatigue produced by a bout of exercise (Figure 1.5). This early research led to the development of the first model to quantify the physiological response to exercise sessions.

The early model (15) for determining TRIMP[†] values utilized a mixed-model approach, later models (12, 69, 116, 147) then replicated this approach. In the mixed-model approach, data from the chosen physiological variable (e.g., blood lactate and HR) was transformed into a quantifiable number, the TRIMP, for the measured practice and/

[†] In 1975, Banister and colleagues (15) devised the term "TRIMP", a combination and contraction of the terms 'training' and 'impulse', to refer to their physiological load value. Owing to the early research by Banister and colleagues, this research is generally referred to as "TRIMPs research." The term "TRIMP" will be used generally to refer to the physiological load. For the sake of specificity, subscripts will be used to indicate specific TRIMP methodologies.

or competition sessions. TRIMP values were approximated for non-sport sessions (i.e., weight lifting). TRIMP values for these sessions were approximated because HR and $\dot{V}O_2$ responses during these non-sport sessions did not correlate well with work performed due to the work-rest ratios (143). As both the sport and non-sport training sessions were expressed in the same terms, they could be combined to present daily and weekly TRIMPs. While this method of quantifying load is useful for coaches, these early approaches have not been validated. This review only considers those studies that use values that assess the physiological strain for use in developing PL quantification models and not the mixed-model approaches.

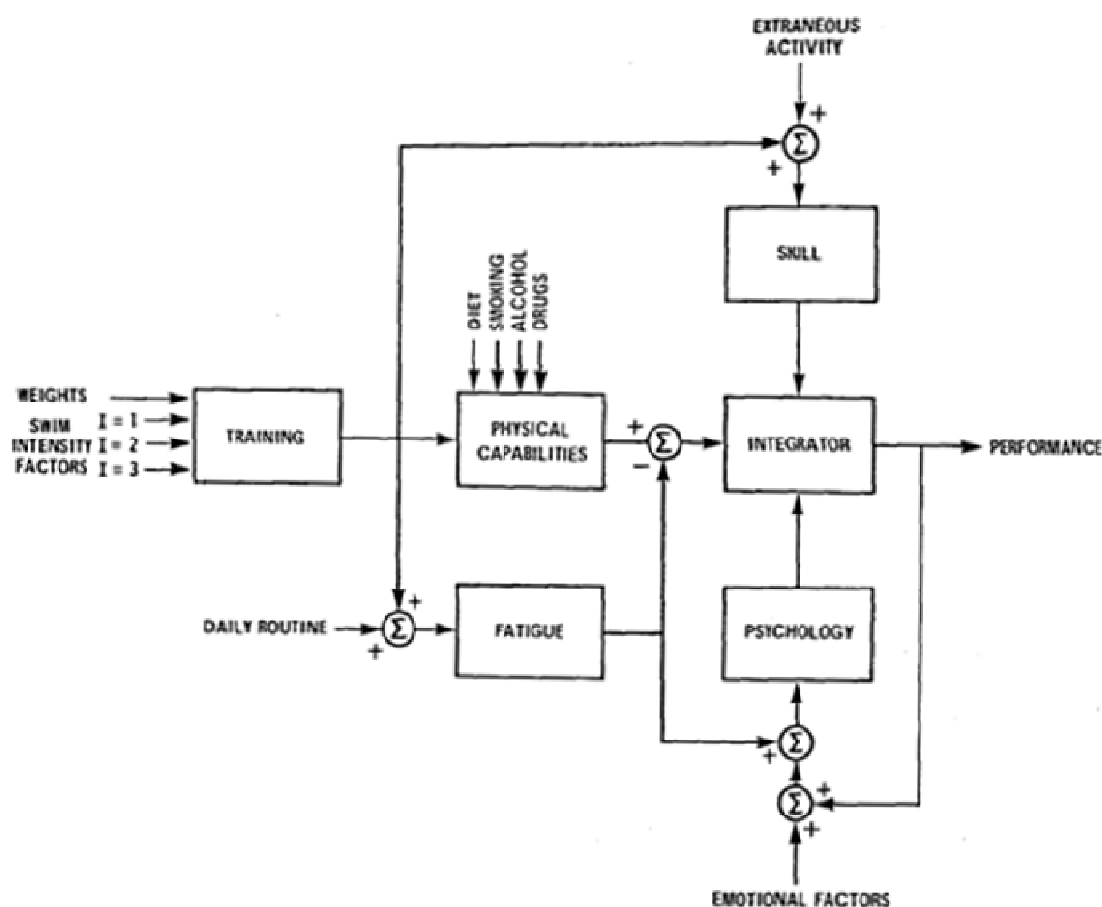

Figure 1.4. Banister and colleagues initial model of factors affecting athletic performance (18) © 1982, from *Physiological Testing of the Elite Athlete*. Used with permission from the Canadian Society for Exercise Physiology.

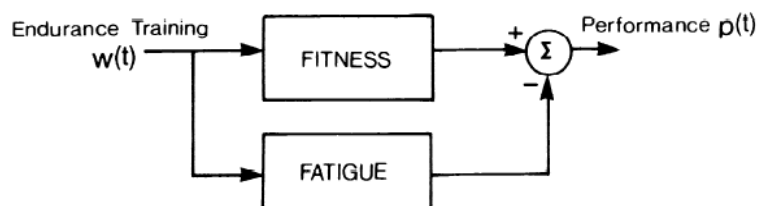

Figure 1.5. The simplified model for the prediction of performance levels based on endurance training. (115) Reproduced with permission from the American Physiological Society.

Methods for quantifying of PL

Different methods for determining the PL, also referred to as internal training load (74), have been proposed. Most of the methods discussed here have correlated laboratory-based variables for physiological tests with variables which are obtainable out in a field-setting. All of these models collect a field variable that is then transformed into a quantifiable term which can be summated for a single session and over multiple sessions. These methods can be classified based on how the data are categorized for quantification.

Some models, for example those presented by Banister and Hamilton (15), Mujika and colleagues (116) and Fricker and colleagues (56), have beend called TRIMPS models but, calculate TL rather than the PL. Therefore, they are presented only as points of reference (Table 1.2).

Table 1.2. Training load/ workload methodologies

Methodology	Model	Predictor Variable
Mean-Intensity	TRIMP _{Fricker}	Miles run
3-Intensity Zone	TRIMP ₇₅	Meters swum
5-Intensity Zone	TRIMP _{Mujika}	Distance swum

$$\text{TRIMP}_{\text{Fricker}} = \text{miles run} \cdot w_z$$

TRIMP _{Fricker} (56)	Zones	w	Intensity level
	5	5	Maximal
	4	4	
	3	3	
	2	2	
	1	1	Light

$$\text{TRIMP}_{75} = (t_{z1} \cdot w_{z1}) + (t_{z2} \cdot w_{z2}) + (t_{z3} \cdot w_{z3})$$

TRIMP ₇₅ (15)	Zones	w	Meters swum during these training activity
	3	3	Quality training, speed swimming
	2	2	Endurance training of harder intensity – long duration
	1	1	Warming up and warming down

Also used in 30, 31

$$\text{TRIMP}_{\text{Mujika}} = (t_{z1} \cdot w_{z1}) + (t_{z2} \cdot w_{z2}) + (t_{z3} \cdot w_{z3}) + (t_{z4} \cdot w_{z4}) + (t_{z5} \cdot w_{z5})$$

TRIMP _{Mujika} (116)	Zones	w	Speed	[HLA]	Physiological Level
	5	8	Not stated	~16	Maximal
	4	5	Not stated	~10	High
	3	3	Not stated	~6	<OBLA
	2	2	Not stated	~4	@OBLA
	1	1	Not stated	~2	<OBLA

Also used in 12, 69, 147

Key T = duration of exercise session in minutes
t = duration of time in each zone in minutes
HR = heart rate
%HR_{max} = percent of maximal heart rate
%HRR = percent of heart rate reserve
z = zone
w = weighting factor
[HLA] = concentration of lactate in blood

Averaged-Intensity PL Methodologies

Three models have been found in the literature that quantify PL by multiplying the averaged-intensity of the event (i.e., a training or competitive session) by the duration of the event. The TRIMP₈₀ (14), and TRIMP₈₆ (17) used HR as their measurable physiological response variable in their quantification schemes (see Table 1.3).[‡] These methods call for the average of only two or three HR values over an exercise bout to be used in the calculation of the TRIMP score. However, TRIMP₈₀ transforms HR values into %HR_{max} values, while TRIMP₈₆ transforms the HR data into %HRR terms. When using the TRIMP₈₀ equation, long periods of time at a low work intensity can produce the same TRIMP value as a training session of shorter duration and higher intensity.

Therefore, an intensity moderator, noted as “y”, was introduced into the equation of the TRIMP₈₆ model (17). The “y” term is the best-fit regression equation from lactate curve data. However, the data used to construct the lactate curves were not collected from these study participants. Banister and colleagues developed gender-specific “y” terms were generated (17).

The other averaged-intensity PL model utilized a psycho-physiological scale, the criterion-referenced 10 point rating of perceived exertion scale (CR10), as the measure of strain from an exercise session. The CR10 scale was devised to measure the perceived intensity for short duration, steady state bouts of intensity which has been shown to be correlated with HR and blood lactate values (117). It has since been used to measure the intensity for exercise bouts (52, 53, 54). Hence, the session RPE (sRPE) method derives

[‡] The appropriateness of heart rate as a measure of the physiological response for the purposes of intensity determination will be presented in a separate section in this section.

a TRIMP score by multiplying the RPE score collected after an exercise session by the duration of the session (54).

Table 1.3. Averaged-intensity PL methodologies

Model	Predictor		Outcome
	Variable	Variable	Equation
TRIMP ₈₀ (14)	%HR _{max}	NA	TRIMP ₈₀ = T • (\bar{x} of 3HR values • 100/ HR _{max})
TRIMP ₈₆ (17)	%HRR	[HLa]	TRIMP ₈₆ = T • (\bar{x} of 3 %HRR values) • y
			$y_{\text{male}} = 0.64e^{1.92\%HRR}$
			$y_{\text{female}} = 0.86e^{1.67\%HRR}$
sRPE (54)	CR10	NA	sRPE = T • CR10

Key CR10 = Borg's Criterion Referenced 10 point RPE scale

HR = heart rate

HR_{max} = maximal heart rate

T = duration of exercise session in minutes

sRPE = Rating of Perceived Exertion for a session

\bar{x} = mean value over the exercise session

%HR_{max} = percent of maximal heart rate

%HRR = percent of heart rate reserve

TRIMP₈₀ was also used in 18.

TRIMP₈₆ was also used in 115, 14, 16, 118, 119, 76, 92), 85, 120.

sRPE was also used in 52, 51, 53, 70, 57.

The use of RPE has been advocated as a reasonable replacement for HR tracking (52, 51, 55, 94, 96), but the correlations between the sRPE score and the HR-based TRIMPs have produced a wide range of relationships. The correlations were weaker for soccer players ($r = 0.50 - 0.85$) (74) than had been presented in previous research ($r = 0.75 - 0.90$) (51). Therefore, further analysis of this claim is needed.

One benefit to the TRIMP₈₀, TRIMP₈₆ and sRPE techniques do not require technological devices. Heart rates can be taken by manual palpation and the CR10 RPE scale can be written on a piece of paper. Therefore, they are readily suited for use in the field and engender little to no cost.

While these methodologies are all intuitively logical, validation and reliability studies have not been conducted in the TRIMP₈₀ and TRIMP₈₆ models. Herman and colleagues (70) proposed that the sRPE model is valid and reliable. Their reliability assessment was supported by test – re-test data from laboratory setting. This model was designed for application in the field, and as such this study is yet to be conducted. The coefficient of determination between the sRPE score and the three measures of physiological strain, $\% \dot{V}O_{2\text{peak}}$, $\%HR_{\text{peak}}$ and $\%HRR$ ($R^2 = 0.76$, $R^2 = 0.76$, $R^2 = 0.71$, respectively), were lower than the coefficients of determination between these variables ($\% \dot{V}O_{2\text{peak}}$ and $\%HR_{\text{peak}}$ $R^2 = 0.88$; $\% \dot{V}O_{2\text{peak}}$ and $\%HRR$ $R^2 = 0.87$; and $\%HR_{\text{peak}}$ and $\%HRR$ $R^2 = 0.98$) (70). These data indicate a weaker relationship between the psycho-psychological measure and the physiological measures than between the physiological measures themselves. Also, at the higher exercise intensities there was a much weaker relationship between these sRPE and objective variables (70). These findings contradict the assertion that the sRPE technique “might be a valid approach to evaluating even very high-intensity exercise” (53). Therefore, the validity claim should be taken with caution. Additionally, the sRPE methodology (54) utilizes a subjective psychometric measure of the physiological response as the intensity variable and not a direct and objective physiological response measure. Due to the duration of the exercise sessions and the work-to-rest ratios, the use of the RPE score should be used with caution. In an attempt to reduce the potential effect of the last activity on the RPE rating for the session, the sRPE score was taken thirty minutes after the conclusion of the exercise session (51, 52, 53, 54) which may not always be possible. No study has been conducted to determine if there is a difference in RPE scores if they were to be taken at the conclusion of or thirty

minutes after the exercise session. Therefore, PL models based on physiological measures may be more accurate.

The TRIMP₈₀, TRIMP₈₆, and sRPE methodologies only present a cumulative value and not data about the physiological responses during the session. When working with athletes, information about the physiological response over time and the different workloads can be useful in tracking the fitness of an athlete and in modifying training programs. These models do not provide this information.

Due to the fact that these methods average the physiological response, these methods are most appropriate for use with steady state activities, like running or cycling, where the physiological response will be steady. For longer exercise sessions where cardiac drift may occur or exercise sessions with intermittent activities, these methods will not provide accurate indications of the strain of the event.

3-Intensity Zone Methodologies

The development of portable telemetric HRMs and microcomputers able to capture and store the telemetric HR data allowed new methodologies to be developed. With these devices the HR responses from an exercise bout can be collected for detailed analysis and used in a quantification scheme after the event. Lucia and colleagues (95) developed a model (TRIMP_{Lucia}) to quantify the physiological response to exercise using HR values anchored on ventilatory rather than HR responses of elite cyclists (Table 1.4). In this model, the HR values were collected and then attributed to the appropriate zone. The amount of time in minutes in each zone was then multiplied by the weighting factor (w) for that zone. The TRIMP scores for each zone were then added to provide a total TRIMP score for the session. By creating three categorical zones and assigning

weighting factors to each zone, this method was able to characterize the amount of time spent in different intensity zones and thus present the physiological responses to training and to attach different metabolic costs to the work performed.

Table 1.4. 3-intensity zone PL methodologies

Model	Predictor Variable	Outcome Variable
TRIMP _{Lucia} (96)	%HR _{max}	Ventilatory thresholds

General model = $(t_{z1} \cdot w_{z1}) + (t_{z2} \cdot w_{z2}) + (t_{z3} \cdot w_{z3})$

TRIMP _{Lucia} (96)	Ventilatory					
	Zones	w	Thresholds	HR (bpm)	%HR _{max}	% $\dot{V}O_{2max}$
	3	3	>RCP	$> 173 \pm 3$	$> \sim 90$	$> \sim 90$
	2	2	VT-RCP	$154 \pm 5 - 173 \pm 3$	$\sim 81 - \sim 90$	$\sim 70 - \sim 90$
	1	1	<VT	$< 154 \pm 5$	$< \sim 81$	$< \sim 70$

Key bpm = heart rate beats per minute
 HR = heart rate
 t = duration of time in each zone in minutes
 RCT = Respiratory Compensation Threshold (or RCP = Respiratory Compensation Point)
 VT = Ventilatory Threshold
 w = weighting factor
 z = zone
 %HR_{max} = percent of maximal heart rate
 % $\dot{V}O_{2max}$ = percent of maximal oxygen uptake

Also used in 40, 55, 47, 41, 128, 144.

The TRIMP_{Lucia} methodology (95) used a scientific and physiological approach, utilizing HR values associated with ventilatory responses. The use of ventilatory responses was proposed due to the relative stability of the ventilatory threshold (VT) and respiratory compensation point (or threshold, RCP or RCT) (96).[§]

[§] Ventilatory threshold (VT) was determined as the point at which ventilation over oxygen uptake ($\dot{V}E \cdot \dot{V}O_2^{-1}$) and the end-tidal partial pressure of carbon dioxide (PETCO₂) both increase with no concomitant increase in minute ventilation over expired carbon dioxide ($\dot{V}E \cdot \dot{V}CO_2^{-1}$). Respiratory Compensation Threshold/ Point (RCP) is determined as the point at which the slopes $\dot{V}E \cdot \dot{V}O_2^{-1}$ and $\dot{V}E \cdot \dot{V}CO_2^{-1}$ increase noticeably while PETCO₂ starts to decrease.

This methodology allows the duration spent in specific training intensity zones to be tracked over time and thus can be useful in determining variations in training intensity. Unlike the averaged-intensity models this model includes all HR response variables in the calculation of the TRIMP score. By creating different zones, the researchers recognize that there is variation in the intensity level during an activity session – either within the same session or between sessions. This feature of the methodology therefore allows it to be used in stochastic sports which are characterized by periods of varying intensities.

However, while this method does enhance the assessment of the PL, it does have a few limitations. The first limitation is that there are only three levels of classification, which is a result of the variable (i.e., ventilatory dynamics) chosen. While these categories could be further divided, there is no physiological rationale for this. The second limitation is the breadth of the zones. When utilizing the TRIMP_{Lucia} method, time spent at a HR response of 160 (at the bottom of Zone 2) and 172 beats per min (at the top Zone 2) are weighted the same. Also, this method categorizes training at 172 (at the top of Zone 2) and 176 beats per min (at the bottom of Zone 3) differently while the magnitude of the physiological response may be more similar than the prior illustration.

Also, to obtain the HR values associated with the ventilatory and respiratory compensation thresholds, laboratory tests need to be conducted. These tests typically have a cost associated with them and therefore may limit its ability to be used with some individuals and groups.

Last, this methodology utilizes an arithmetic scale for the weighting factors. This is a limitation in that there is no physiological basis for the numerical value of the weighting factor and for the difference between weighting factors for each stage.

5-Intensity Zone Methodologies

Models with five intensity zones have also been proposed (Table 1.5) as well. They function in the same manner as the $TRIMP_{Lucia}$ model when calculating TRIMP scores. These methodologies (43, 137, 157) track HR during training or competitive sessions as the physiological response variable (Tables 1.5). However, they differ with regards to the ranges of their zones and their weighting factors. $TRIMP_{Wood}$ (157) and $TRIMP_{mod}$ (137) associate HR values with blood lactate responses as the physiological determinant for their categorical zones. The Heart Zone Training system (HZT) (43) uses zones of ten-percent of $\%HR_{max}$. The $TRIMP_{Wood}$ method modified a previously created model (116) which sets the zones at arbitrary lactate zones, with the exception being Zone 2 which is set to contain the onset of blood lactate (OBLA; 4 millimolar of lactate • liter of blood⁻¹ (mmol • l⁻¹)). The intensity zones for the $TRIMP_{mod}$ technique were established using the extrapolated values of lactate threshold (LT, 1.5 mmol • l⁻¹) and the OBLA to anchor Zones 2 and 4, respectively. Zones of 7% of HRR (which was referred to as the fractional elevation of HR) were created, thus establishing the five intensity zones. Edwards (43) provided no rationale for creating zones that were 10%.

Table 1.5. 5-intensity zone PL methodologies

General Model: score = $(t_{z1} \cdot w_{z1}) + (t_{z2} \cdot w_{z2}) + (t_{z3} \cdot w_{z3}) + (t_{z4} \cdot w_{z4}) + (t_{z5} \cdot w_{z5})$

Model	Predictor Variable	Outcome Variable
HZT (43)	%HR _{max}	NA
TRIMP _{Wood} (157)	relative HR values	NA
TRIMP _{mod} (137)	%HRR	[HLa]

Model	Zones	w	Intensity	HR values
HZT (43)	5	5	Redline	90 – 100 %HR _{max}
	4	4	Threshold	80 – 90 %HR _{max}
	3	3	Aerobic	70 – 80 %HR _{max}
	2	2	Temperate	60 – 70 %HR _{max}
	1	1	Healthy Heart	50 – 60 %HR _{max}
TRIMP_{Wood} (157)	5	16	Maximal	>(HR _{max} -5bpm)
	4	10	High	(HR _{VT} +5bpm) – (HR _{max} -5bpm)
	3	6	> OBLA	(HR _{VT} -5bpm) – (HR _{VT} +5bpm)
	2	4	@ OBLA	[50% HRR + ((HR _{VT} -5bpm) – 50% HRR)/2] – (HR _{VT} -5bpm)
	1	2	< OBLA	50%HRR – [50% HRR + ((HR _{VT} -5bpm) – 50% HRR)/2]
TRIMP_{mod} (137)	5	5.16	Maximal	93 – 100 %HRR
	4	3.61	OBLA	86 – 96 %HRR
	3	2.54	Steady State	79 – 86 %HRR
	2	1.71	Lactate Threshold	72 – 78 %HRR
	1	1.25	Moderate	65 – 71 %HRR

Key bpm = heart rate beats per minute
 e = Naperian natural logarithm = 2.71828182845904
 HR = heart rate
 OBLA = Onset of Blood Lactate Accumulation (4.0 millimolar of lactate • l⁻¹ blood)
 T = duration of exercise session in minutes
 t = duration of time in each zone in minutes
 w = weighting factor
 x = %HRR
 z = zone
 %HRmax = percent of maximal heart rate
 %HRR = percent of heart rate reserve
 [HLa] = concentration of lactate in blood

HZT was also used in 51, 53.

Each methodology used a different type of weighting scales. The TRIMP_{mod} model utilized an exponential line of best-fit regression equation to generate a formula for their weighting factors. The TRIMP_{Wood} method uses the approximated lowest lactate values of each zone as the weighting factor. The difference between the first three zones is 2 units and then it increases to 4 and 6 units for the highest two zones, respectively. This design is similar to that proposed by Mujika and colleagues (116) (Table 1.2), however the TRIMP_{Wood} technique used the approximated lactate values from the TRIMP_{Mujika} model as their weighting factor. The only standard lactate values used in the TRIMP_{Wood} model is OBLA (i.e., 4 mmol • l⁻¹) and possibly LT (which has been presented as either 1.5 or 2.0 mmol • l⁻¹). Similar to TRIMP_{Lucia}, the HZT method employs a linearly increasing scale where the zone numeral is the weighting factor.

TRIMP_{mod} utilizes a team-approach to their analysis by utilizing all of the lactate values from the sub-maximal and maximal effort tests to create the lactate curve from which they generated their weighting factors (143). This is a unique approach.

TRIMP_{Wood} was generated for a single distance runner (157). No information about the formation of the HZT model was presented.

These methods, similar to the TRIMP_{Lucia} method, are useful in characterizing the response to the activity; however they all create a low level threshold. Therefore, any time spent below this low level threshold will not be incorporated into the TRIMP score. Thus, as stated previously, each of these methods exclude data below this threshold. Therefore, during an exercise bout if athletes are able to recover quickly and reach HR values below these thresholds, that data would not be considered in the calculation of the TRIMP value. An analysis of the data used in one of our studies with youth ice hockey

players (155) revealed that during training sessions between 0.0 – 20.4% and 1.4 – 38.1% of the data were not included in the TRIMP score when utilizing the HZT and the TRIMP_{mod} models, respectively. Therefore, the HZT and TRIMP_{mod} scores for the events tracked did not produce accurate PL scores. This fact complicates comparing different exercise bouts.

As these methods have narrow exercise intensity zones, activities of similar intensities are more likely to be classified together and likewise different intensities to be classified differently. This can be seen as an improvement over the TRIMP_{Lucia} method.

TRIMP_{mod} and TRIMP_{Wood} models associate the HR responses during field work with the blood lactate response from laboratory testing. This allows the HR response to be correlated to a standard measure of workload intensity which reflects the curvilinear nature of the physiological and metabolic costs of workload differences. The weighting factors for the TRIMP_{mod} (137) method were established from the regression equation utilizing the lactate responses at given %HRR values for all study participants. The researchers chose to base their equation on the Napierian logarithm, similar to Banister and colleagues (17). This type of analysis assumes that the HR and [HLA] responses for individuals are similar, which could be seen as a limitation. However, this was a rather homogeneous sample and thus the generation of a single regression equation from these data can be seen as a technique to deal with what would otherwise be a data set with only a few values.

For athletes working without coaches or with a limited budget, the HZT method can be used as no testing is required to determine the zones. A HR_{max} can either be predicted or taken from a training session (43). However, the lack of physiological criteria for the

creation of the five zones is a limitation. Also, the use of linear weighting factors in this model presents the same limitations as with the $TRIMP_{Lucia}$ model. Therefore, the scientific basis for this model should be explored before it is used in scientific research.

While the establishment of five zones is an improvement on the previously discussed methods, some have still seen this as too few categories for properly classifying the “large number of training variables” incorporated into training programs by coaches (69).

Continuous-tracking PL Methodologies

Recognizing the limitations of the previous models and with the ability to continuously measure, methods were devised to provide a weighting for each HR data point. As such, all of these models track HR and express it in relative terms, the $TRIMP_{Millet}$ and $TRIMP_i$ models use %HRR (98, 107) and $TRIMP_{fit}$ uses %HR_{max} (63) (Table 1.6). Each of these methods also use the blood lactate concentration associated with an observed HR value. $TRIMP_{Millet}$ (107) and $TRIMP_i$ (98) utilize equations similar $TRIMP_{86}$ (17). The $TRIMP_i$ method generates individual “y” terms, (noted as “y_i”) for each study participant, rather than using the general “y” terms used in the $TRIMP_{86}$ model. The “y_i” term is the exponential non-linear regression equation from each individual’s lactate curve from the laboratory tests conducted. The $TRIMP_{fit}$ model generates a unique best-fit polynomial regression equation for each participant.

The general benefit and strength of these models is that they incorporate each HR value in the calculation of the TRIMP score. This allows the stochastic nature of training sessions and competitions to be included.

Table 1.6. Continuous-tracking PL methodologies

Model	Predictor Variable	Outcome Variable
$\text{TRIMP}_{\text{Millet}}$ (107)	%HRR	[HLa]
$\text{TRIMP}_{\text{fit}}$ (63)	%HR _{max}	[HLa]
TRIMP_i (98)	%HRR	[HLa]

Model	Equation
$\text{TRIMP}_{\text{Millet}}$ (107)	$\text{TRIMP}_{\text{Millet}} = \sum (\text{sr}^{-1} \cdot \% \text{HRR}_i \cdot k)$ $k_{\text{male}} = 0.64 \cdot \% \text{HRR}_i \cdot e^{1.92\% \text{HRR}_i}$ $k_{\text{female}} = 0.86 \cdot \% \text{HRR}_i \cdot e^{1.67\% \text{HRR}_i}$
$\text{TRIMP}_{\text{fit}}$ (63)	Individual best-fit polynomial of [HLa] against %HR _{max}
TRIMP_i (98)	$\text{TRIMP}_i = \sum (\text{sr}^{-1} \cdot \% \text{HRR} \cdot y_i)$

Key e = Naperian natural logarithm = 2.71828182845904
 sec = second
 $t_{/60}$ = rate for heart rate sampling expressed as a fraction of a minute
 y_i = individual best-fit equation for lactate curve
 $\% \text{HRR}_i$ = individual percent of heart rate reserve values
 [HLa] = concentration of lactate in blood
 sr = sampling rate of HR monitor (i.e., the number of values reported in 1 min)
 \sum = sum of

$\text{TRIMP}_{\text{Millet}}$ was also used in 108.

TRIMP_i was also used in 99.

While each of the models utilize each HR value in the computation of the PL score, their methodologies are quite distinct. $\text{TRIMP}_{\text{Millet}}$ utilizes the same structure as the TRIMP_{86} but it calculates a TRIMP score for each HR value rather than using the overall average for the session. The “y” term in the TRIMP_{86} model is the same variable as the “k” term in the $\text{TRIMP}_{\text{Millet}}$ model. This modification of the $\text{TRIMP}_{\text{Millet}}$ enhances its utility with team sport athletes, but the use of an intensity moderator which is not based on the [HLa] curve of the sampled group reduces the specificity of the TRIMP score. The TRIMP_i method addresses this generic “y” issue by using individualized intensity moderators. $\text{TRIMP}_{\text{fit}}$ inputs the %HR_{max} value into unique third to fifth degree polynomial best-fit equations from the lactate-%HR_{max} curves. It must be ensured that

these formulae are physiologically reasonable. That is the curves produced cannot lead to unrealistic lactate values (i.e., negative lactate values) at the lower HR values.

Overall the models previously developed for the quantification of PL have strengths and weaknesses. Some of the impact of the limitations can be reduced by using them in appropriate situations (i.e., using the TRIMP₈₀ or TRIMP₈₆ models with individuals engaged in steady-state trainings and competitions). Combining the strengths of the models to create a single methodological approach (i.e., model) is warranted.

Validity of heart rate

Nine of the ten models for determining the PL during exercise use HR as their field measure. Therefore, it is important to review the appropriateness of using HR data collected in the field as a measure of work and intensity as its utility has been criticized (53).

Heart rate monitoring in the field has been possible since the 1970's with the production of telemetric monitoring straps that could detect the "R" segment of a heart beat wave and portable microcomputers capable of storing the HR data. The devices have been tested against standard electrocardiogram devices and have been shown to be valid and reliable for the *in situ* determination of HR (1, 21, 34, 39, 42, 81, 84, 90, 97, 131, 146, 149).

Some researchers have expressed concerns about the use of HR as a measure of intensity due to a diminishing correlation between it and $\dot{V}O_2$ at high intensities (10, 82). To address this issue, Esposito and colleagues (46) collected HR and $\dot{V}O_2$ data on soccer players during field tests at different intensities and found no statistical difference

between the two variables at each intensity level. This supports the use of HR as a valid and reliable measure of workload and energy expenditure for stochastic bouts of exercise. While $\dot{V}O_2$ has been a very reliable variable in determining workload, the difficulty in directly and continuously measuring $\dot{V}O_2$ during practice sessions has been recognized (31).

Heart rate data has been collected and used by coaches and researchers in field settings. It has been asserted that HR is “the most useful parameter for evaluating the level of intensity attained during training sessions and competitions in professional cycling” (95), and “seems to be one of the best objective ways to quantify aerobic training intensity” (1, 61, 74). It has also been proposed as a useful variable in clinical as well as recreational sports setting (82).

Methodological concerns about tracking HR using monitors during an entire exercise session have been expressed (53, 54, 55). It cannot be denied that technological devices do not always function as desired and that human participants are not always compliant. However, these issues can be addressed and managed. The equipment should be regularly assessed and if necessary tested to ensure the units are functioning properly. To increase adherence, researchers (and coaches) should express their rationale for and the benefits of being tracked. It may also be possible to check with participants (and athletes) to make sure they are wearing the necessary equipment. When working with participants and athletes remotely, there is less control and ability to ensure adherence, and therefore explaining the importance and benefits of wearing the monitor and sending the collected data are more crucial. Today, devices such as the Polar Team Heart Rate Monitoring Systems require only a chest-worn HRM for the collection of data.

Therefore, only one piece of equipment is required, which increases the simplicity of the process. It should also be noted that the concerns over the collected HR data were expressed in a study which proposed a non-HR methodology for quantifying training intensity (53), and the principle researcher had collected HR data in this study and in subsequent studies (53, 55). Eniseler (45) expressed a contradictory opinion stating “since heart rate data collection is not complicated and causes little inconvenience to the players, it can be speculated that the HR values can be used as a key variable to estimate playing intensities during a soccer game.” Several studies have advocated the use of HRMs during physical exercise as a method of determining the physiological response (81, 84, 131, 146).

The models that collect HR data for the duration of a training session, typically for 1 – 2 hours, result in a large amount of data that must be downloaded and then processed. Therefore, the methods that propose the collection of HR values during an entire exercise session require more time to produce a TRIMP score than the Averaged-Intensity methods. However, the richness of the data and ability to analyze specific periods during the session may outweigh this perceived inconvenience.

Therefore, HR data during the entirety of an exercise bout is useful and when possible should be collected.

Summary

Athletes subject themselves to stress on a regular basis with the goal of improving their performance. While it is important to know and plan their training load, it may be more useful to calculate their strain, as measured by the physiological load, in response to training and competition. Several methodologies have been proposed and utilized over the years, and each group of techniques as well as each individual technique has strengths and limitations.

Researchers have called for other measures to be considered as indicators of strain in the hopes of developing a more sensitive multifaceted methodology for the quantification of PL (37, 45, 52, 69, 116). As this review indicates, most of the current methodologies use a single variable, HR, as the measure of intensity, and lactate, as the measure of work.

Statement of Purpose

The primary purpose of this dissertation was to construct models to be used in the quantification of physiological load for National Collegiate Athletic Association (NCAA) Division I (DI) soccer players using recently developed technology. Secondary purposes of this dissertation were to assess the internal concurrent validity of these resulting quantification models and to assess the degree of difference and similarity between the scores of the new models and the previously developed models.

Aims of the Study

The overall aims of this dissertation were to devise mathematical models (or possibly a single model) for quantifying the PL of soccer players during practice and competition sessions. This was achieved by:

1. determining a set of valid and reliable field-obtainable continuous variables,
2. determining the levels of difference and agreement between the proposed PL quantification model(s) (PLQ) (women's model: PLQ_{WS} , men's model: PLQ_{MS}),
3. assessing the validity of each proposed model,
4. comparing the scores from the PLQ models to the scores from the PL models presented by other researchers.

Hypotheses

Multiple hypotheses were developed pertaining to the overall and specific aims. It was hypothesized that:

1. the resulting mathematical models (i.e., equations) would incorporate multiple variables,
2. the variable(s) incorporated in the models with %HRR would be ventilation rate (VR) and/ or "activity" (ACT),
3. the PLQ_{WS} model would be different from the PLQ_{MS} model due to physiological and training differences between the two teams,

4. due to greater levels of fitness, the scores generated from the PLQ_{MS} model would be lower than the scores from the PLQ_{WS} model when the same data were entered into each equation,
5. the scores from the PLQ_{WS} and PLQ_{MS} models would be strongly to very-strongly correlated ($r \geq 0.60$) with the objective measures of physiological work for the stages of the sub-maximal effort tests and would have a high level of agreement between the measured and predicted objective measures of PL,
6. entering the same data into the PLQ_{WS} and the PLQ_{MS} and the previously presented models would result in statistically different PL scores, resulting in some statistically different scores and a wide range of correlations.

SECTION 2: Methodology

Study design

Two NCAA Division I collegiate soccer teams were recruited to participate in this study. A women's soccer team was recruited for the first round of data collection. A men's soccer team was recruited for the second round of data collection.

The players were enrolled in the study before their pre-season practice started. Enrollment consisted of completing the Informed Consent Documents and Health History Questionnaire (see Appendix B and C) as stipulated by the Institutional Review Board (IRB) at the University of Wisconsin – Milwaukee (UWM). For those players under the age of 18 years old, their assent and their parent's consent were obtained. During an introductory session, participants completed the aforementioned documents. At that time, the nature of the study and what they would be asked to do was explained.

After their enrollment but prior to the start of their pre-season training, participants completed sub-maximal and maximal effort tests in the Human Performance Lab in room 130 of Enderis Hall on the campus of UWM. For the testing of the women's soccer players the starting stage for the sub-maximal test began at a speed which induced a HR of ~140 beats per min. At the beginning of each stage the speed was increased by 0.8 km • hr⁻¹. Willing participants were allowed to continue past LT. The duration of each stage was 6 min. Male participants completed a sub-maximal protocol with a fixed starting speed. Their protocol increased incline by the same amount but increased speed by 2.0 km • h⁻¹ at the beginning of each 6 min stage.

Participants wore the Zephyr Bioharness around the chest, inferior to their pectoral muscles, and a Polar Team1 HRM superior to the pectoral muscles and inferior to the

clavicle bones. Both devices were in contact with the participant's skin. The participants also wore the Cortex MetaMax 3B portable gas analyzer for continuous gas analysis.

During the test HR was noted at each minute using a Polar microcomputer (e.g., a wrist-worm display device) which can detect the telemetric signal from the Polar Team1 HRM and the Zephyr OmniSense Live software program. During the fifth minute, the participant/ athlete provided their subjective rating of the difficulty of the test using a modified version of the Borg Criterion Reference 10-point RPE scale (mCR10). In addition, a sample of blood was drawn from a fingertip for analysis to determine the concentration of lactate in the blood ([HLA]). A 50 microliter (50 μ l) sample was drawn from the women and a 5 μ l sample was drawn from the men as per the requirements of the analysers.

Two Human Performance Lab Modified Conconi (HMC) protocols were used to assess maximal values (i.e., HR, $\dot{V}O_2$ and [HLA]). The HMC protocols are ramped protocols, where the speed and incline are increased alternately (see Tables 2.4 and 2.5). During this test, the participants wore the same equipment as in the sub-maximal effort test. Again, HR and RPE were collected at the end of each 1 min stage. The stages were 1 min in duration and therefore did not produce a steady-state in [HLA], thus a sample for the determination of [HLA] was only taken 1 min after the conclusion of the test.

Participants/ athletes wore the Polar Team1 HRM during all team events. This included practices, scrimmages, and competitions. The participants/ athletes wore the device in one of three positions: 1) around the chest and inferior to the pectoral muscles with the transmitter belt across the front of the chest, 2) around the chest and inferior to

the pectoral muscles with the transmitter belt across the back, or 3) superior to pectoral muscles and inferior to clavicle bones.

Aims and Hypotheses

Overall aim

The overall aim of this research project was to devise mathematical models to be used in the quantification of PL during practices and competitions for female and male National Collegiate Athletic Association (NCAA) Division I (DI) collegiate soccer players. Data from the sub-maximal and maximal effort tests were used to construct these models. This overall aim was obtained through the fulfillment of four specific aims.

Specific aims and hypotheses

Specific aim 1

The first specific aim was to determine what variables (which can be collected in the field in a continuous manner) produce the best mathematical model for the quantification of PLs for soccer players.

This was accomplished by having players wear physiological monitors during their sub-maximal and maximal effort tests. These monitors collected data on the following variables: heart rate (HR), ventilation rate (VR), activity (ACT), percent of maximal heart rate ($\%HR_{max}$), body posture (BP), skin temperature (ST), and peak acceleration (PkA). Percent of heart rate reserve ($\%HRR$) was calculated using the Karvonen method (82). The participants also wore a standard HRM and had blood samples collected for [HLA] determination.

Hypothesis 1

As exercise intensity increases, the variables listed above are expected to change. Previous research has shown that a relative form of HR, either %HR_{max} or %HRR, to be a reliable field-based measure of intensity. Hence, it was hypothesized that an equation which incorporates multiple variables would produce the best-fit regression equation.

Hypothesis 2

As exercise intensity increases, VR and the amount of movement/ force produced by the body increases as well. Therefore, it was further hypothesized that the VR and/ or ACT values in conjunction with the %HRR values would produce a better fit equation than using %HRR alone. It was expected that the combined interaction between movement (as measured by the ACT value), the VR and %HRR would be a more sensitive measure of physiological load.

Specific aim 2

Previous studies have shown that male and female soccer players are different with regards to physical characteristics and physiological abilities (11, 73). Also, as the styles of play are typically different between male and female soccer teams, the sport-specific fitness requirements are different. Therefore, it was reasonable to expect that the PLQ schemes would be different as well. The second specific aim was to determine if the two newly proposed models were different from each other.

Hypothesis 3

It was proposed that these models would be different due to physical, physiological and training differences between the two teams.

Hypothesis 4

Some studies show that male soccer players may have a greater level of physical fitness (i.e., lower $\dot{V}O_2$ and [HLA] at the same workload, higher $\dot{V}O_{2peak}$). Therefore, it was hypothesized that the PLQ_{MS} model would produce a lower score than the PLQ_{WS} model for the same bout of exercise and that the scores would be strongly related but statistically different for the same exercise bout.

Specific aim 3

It is important to establish the level of relationship between the PL scores obtained from the models and objective data obtained during the performance tests. A very strong correlation between the scores and the data will establish the degree of validity for the models. Therefore, the third specific aim was to determine the relationship between the PL scores for each proposed model and the objective data ($\dot{V}O_{2-abs}$, $\dot{V}O_{2-rel}$, $\% \dot{V}O_{2max}$, and $\% \dot{V}O_{2R}$) collected during the sub-maximal effort tests.

Hypothesis 5

The proposed PL quantification (PLQ) models used each available HR value. Therefore it was hypothesized that there would be a strong to very-strong correlation between the PLQ scores and the objective measures of physiological intensity for the stages of the sub-maximal effort tests and a high level of agreement between the measured and predicted objective measures of physical work.

Specific aim 4

The fourth specific aim was to compare this methodology to previously proposed models of training load quantification.

Hypothesis 6

The difference in the method of determination, the precision and the sensitivity of the models constructed to quantify training load was expected to result in statistically different TRIMP/ PL scores. It was expected that these scores would vary within and between models, and thus the relationship to the PLQ score would change as well. Hence, it was hypothesized that there would be a wide range of correlations between the PLQ scores and the PL/ TRIMP scores when using the same dataset.

Timeline

Data collection for these studies began before the start of NCAA approved pre-season training and continued for through the season.

Participants came into the HPL before their first testing session for an intake meeting. During this meeting the nature and tasks of the study were presented and discussed, and participants completed the necessary paperwork. Testing for the women's team involved two sessions. During the first session participants completed the sub-maximal effort test. On the second visit, they completed the maximal effort test. The men completed both the sub-maximal and maximal effort tests during the same visit. The test protocols were explained during the intake meeting and then reiterated when the participants came in for their testing session.

Institutional Review Board (IRB) approval

Approval for this study was obtained from the Institutional Review Board of the University of Wisconsin – Milwaukee. The IRB study number was 07-02-172 (see Appendix A).

Consent procedure

Members of the teams were provided via e-mail with the Informed Consent Document (ICD) and Health History Questionnaire (HHQ) prior to coming into the Human Performance Lab (HPL) located in room 130 of Enderis Hall (2400 E. Hartford Avenue, Milwaukee, WI 53211). Upon arrival, the purpose and procedures of the study were reviewed with each participant. Participants were given an opportunity to ask questions related to their participation in the study. They were informed that their participation in any and all parts of the study was voluntary, and that they could withdraw at any time for any reason and that while they may be asked for their reason they need not provide one.

Each ICD form was reviewed by a member of the research team to ensure that the document was complete (Appendices B (for women) and C (for men)).

Completed ICDs were filed in a file cabinet in a locked room.

Participants were offered a blank copy of the ICD to keep if they wished.

Assent procedures

For study participants who were under the age of eighteen years, consent was sought and obtained from a parent or legal guardian and assent was obtained from the minor. The details and expectations of the study were stated using terms that were age-appropriate for the assenting minor.

Health History Questionnaire

All study participants completed the Health History Questionnaire (HHQ) approved for the study (Appendices B (for women) and C (for men)). The HHQ document was reviewed by a trained member of the research team to ensure it was filled out completely

and correctly. When appropriate, the participant was asked for more details regarding injuries or illnesses experienced by either themselves or family members. When participation in the study was determined to potentially exacerbate known conditions for a given participant/ athlete, that individual was excluded from participation.

Equipment

Woodway Desmo slatted treadmill

(WOODWAY, Waukesha, WI, United States of America)

All laboratory-based sub-maximal and maximal effort tests were conducted on a Woodway Desmo slatted treadmill. The unit has a speed range of 0.1 – 24.3 km • h⁻¹ and an incline range of 0.1 – 14.4 %. Speed and incline were controlled through an external control panel by a member of the research team.

YSI Sport1500 Lactate Analyzer

(YSI, Yellow Springs, OH, United States of America)

The YSI Sport1500 Lactate Analyzer was used to measure the concentration of lactate in lysed whole blood samples. A two-step chemical reaction is used to determine the lactate concentration. This unit has been shown to be valid and reliable (2, 22, 103, 105, 152).

For analysis in a YSI 1500 Sport, samples of 50 µl of blood was hemolyzed in 100 µl of buffer (Buffer: 10.0 ml stock buffer solution + 0.44 ml Triton X-100 detergent + 50 g Sodium Fluoride (NaF) Anhydrous MW 42.0).

This device was used during the data collection with the women's soccer team.

Lactate Pro Analyzer

(Arkray Factory Inc., KDK Corporation, Shiga, Japan)

The Lactate Pro Analyzer measures the concentration of lactate in whole blood samples. A two-step chemical reaction is used to determine the lactate concentration.

This unit has been shown to be valid and reliable (103, 105; 122, 145).

Approximately 5 μl of blood were drawn into the sensor strip for the determination of blood lactate concentration by the Lactate Pro.

This device was used during the data collection with the men's soccer team.

MetaMax 3B Portable Gas Analysis System

(Cortex Biophysik, GmbH, Leipzig, Germany)

The MetaMax 3B is a breath-by-breath gas analysis system used for the determination of oxygen uptake ($\dot{V}\text{O}_2$). The unit measures the volume of inspired and expired air using a turbine and the amount of inspired and expired oxygen using an electrochemical cell.

The unit was calibrated as per manufacturer's guidelines.

MetaSoft software (version 3.0)

(Cortex Biophysik, GmbH, Leipzig, Germany)

The MetaSoft software was used to download data from the MetaMax 3B and export $\dot{V}\text{O}_2$ data for transformation and analysis.

Rating of Perceived Exertion Scale

Participants provided their subjective psychological rating of perceived exertion (RPE) in reference to the modified Borg criterion referenced 10-point rating of perceived exertion scale (mCR10) (Table 2.1).

Table 2.1. Modified Borg criterion referenced 10-point rating of perceived exertion scale (mCR10)

Rating of perceived exertion scale
(Modified criteria referenced 10-point scale)

0	Nothing
.5	Very, very slight
1	Very Slight
2	Slight
3	Moderate
4	Somewhat Hard
5	Hard
6	
7	Very Hard
8	
9	Very, very Hard
10	Maximal

Polar Team1 Heart Rate Monitors

(Polar Electro, Oy, Kempele, Finland)

During all laboratory-based sub-maximal and maximal effort tests HR data were collected using chest-worn Polar Team1 coded heart rate monitors (HRM). The monitor detects the R-R interval and by a proprietary mathematical formula determines the number of peaks during a five second period. This methodology has been shown to be valid and reliable for the *in situ* determination of HR (131, 149).

The HR data were broadcasted via radio telemetry and viewed *in situ* by using a Polar microcomputer wrist-worn receiver.

The HR data were stored in a memory module in the HRM and downloaded to the Polar ProTrainer 5 (version 5.00.100) Professional Training Software via a cabled interface. The HR data were presented as the mean of the previous five-seconds. Each monitor stored approximately eleven hours worth of HR data.

Polar Vantage XL and F6 wrist-worn microcomputers

(Polar Electro, Oy, Kempele, Finland)

The Polar Vantage XL and F6 devices are wrist-worn microcomputers capable of receiving the telemetric signal from the Polar Team1 HRM. One or both devices were used during testing to determine *in situ* HR values.

Polar ProTrainer 5 (version 5.00.100) Professional Training Software

(Polar Electro, Oy, Kempele, Finland)

The Polar ProTrainer 5 (version 5.00.100) Professional Training Software (PPT v.5.00.100) was used to download the HR data from each Polar Team 1 HRM. HR data, expressed as five-second averages, were imported into the Microsoft Excel program for further analysis.

Version 5.00.100 was not the current version. However, technical difficulties had been experienced with the current version of the software when importing data from the monitors. These issues were not existent in PPT v.5.00.100. There were no known changes in the newer software that deemed the PPT v.5.00.100 to be less capable and less preferable than the newer version.

Bioharness Physiological Monitoring System

(Zephyr Technologies, Inc, Auckland, New Zealand)

The Zephyr Bioharness Physiological Monitoring System was used to collect HR, ventilation rate (VR), activity (ACT), body posture (BP), peak acceleration (PkA) and skin temperature (ST) data. Data was viewed during testing using the OmniSense Live software program and then exported from the OmniSense database using the OmniSense Analysis software for use in Microsoft Excel.

OmniSense Live (version 2.2.19) software

(Zephyr Technologies, Inc, Auckland, New Zealand)

OmniSense Live allowed for real-time tracking of the variables collected by the Zephyr Bioharness via radio telemetry to a USB–antenna.

OmniSense Analysis (version 2.2.19) software

(Zephyr Technologies, Inc, Auckland, New Zealand)

OmniSense Analysis allowed for the review and export of the data for the variables collected by the Zephyr Bioharness. Data collected during a test that was not able to be collected by the OmniSense Live program was downloaded into this program for review and export.

Microsoft Office Excel 2007

(Microsoft Corporation, Redmond, WA, United States of America)

Excel is a database and data analysis program in the Microsoft Office package. This program was used to review, transform and organize data for analysis by statistical software packages (i.e., IBM SPSS Statistics 19 and Minitab 16).

This package was also used to construct the Bland-Altman Plots.

IBM SPSS Statistics 19

(International Business Machines Corp., Armonk, NY, United States of America)

IBM SPSS Statistics 19, a statistical analysis package, was used to run the non-regression based statistical analyses.

Minitab (version 16)

(Minitab Inc., State College, PA, United States of America)

Minitab 16, a statistical analysis and mathematical program, was able to incorporate multiple variables when running polynomial regression analyses. It was used to run the univariate and multivariate regression analyses by linear and non-linear means to construct the PL quantification models.

Variables

Blood lactate concentration ([HLa])

The lactate concentration from drawn blood samples was used as a measure of exercise intensity. Resting blood lactate concentrations [HLa] range between 0.5 – 2.0 mmol • l⁻¹ (62, 102).

Heart rate (HR)

The Polar Team1 monitors collected and presented HR data in 5 sec averages. The Zephyr Bioharness monitor sampled and reported HR data at 1 Hz (1.008 seconds).

Activity (ACT)

The Zephyr Bioharness system contains a non-gyroscopically controlled tri-axial solid-state accelerometer which measured the force of movement in the sagittal, frontal and transverse planes. The movement forces were then summed and presented as a single unit termed activity (ACT) in vector magnitude units (VMU). ACT values ranged from 0 – 5.7 VMU. The Zephyr Bioharness monitor sampled data and reported ACT data at 18 Hz (0.056 sec) and 1 Hz (1.008 sec), respectively.

Ventilation rate (VR)

The Zephyr Bioharness monitored ventilation rate, the number of breathes $\cdot \text{min}^{-1}$, and data were sampled and reported at 18 Hz (0.056 sec) and 1 Hz (1.008 sec), respectively.

Peak acceleration (PkA)

Peak acceleration (PkA) was determined as the maximum three-axis acceleration magnitude achieved during the previous 1 sec epoch. PkA values had a measurement range of 0 to 5.7 VMUs. The Zephyr Bioharness monitor sampled data and reported PkA data at 18 Hz (0.056 sec) and 1 Hz (1.008 sec), respectively.

Posture (BP)

Posture (BP, the forward or backward tilt of the upper torso) has a measurement range of -90.0 – 90.0, where a value of -90.0 indicated a posterior (backwards) lean and a value of 90.0 indicates an anterior (forward) lean. BP was measured in degrees ($^{\circ}$); a positive or negative value indicates the direction of the tilt. The Zephyr Bioharness monitor collected and presented BP data at 1 Hz (1.008 sec).

Skin temperature (ST)

Skin Temperature (ST) was determined using a near-infrared sensor in the Zephyr Bioharness clip-on module with a range of 10 – 60 $^{\circ}$ C. The Zephyr Bioharness monitor collected and presented ST data at 1 Hz (1.008 sec).

Maximum heart rate (HR_{max})

The OmniSense Analysis software for the Zephyr Bioharness calculated the HR_{max} using the formula as presented by Inbar and colleagues (75) (Equation 2.1).

$$HR_{\max} = 205.8 - (0.685 \cdot \text{age}) \quad 2.1$$

Where “age” was the age of the participant/ athlete in whole years.

Percent of maximum heart rate (%HR_{max})

The OmniSense Analysis software calculated the %HR_{max} using the formula in Equation 2. 2 (75, 127).

$$\%HR_{\max} = HR \cdot HR_{\max}^{-1} \quad 2.2$$

Where “HR” was the heart rate data point of interest and “HR_{max}” was the maximum heart rate as determined by the Inbar formula (Equation 2.1).

Percent of Heart Rate Reserve (%HRR)

Karvonen and Vuorimaa (81) devised an alternative formula for the determination of a percent of maximum HR . This formula is more sensitive than the %HR_{max} formula (Equation 2.1) as it takes into consideration not just the maximum HR but also the minimum (or resting) HR (Equation 2.3).

$$\%HRR = (HR_{\text{exer}} - HR_{\text{rest}}) \cdot (HR_{\max} - HR_{\text{rest}})^{-1} \quad 2.3$$

Where “HR_{exer}” was the HR data point of interest, “HR_{rest}” was the resting HR value, and “HR_{max}” was the maximum HR. In place of a true resting HR for the HR_{rest} value for each study participant/ athlete, the lowest HR value recorded while wearing the HRM was used. HR_{max} was determined from the maximal effort test that the participant/ athlete completed.

Physiological Tests

All participants/ athletes wore a Polar Team1 HRM and a Zephyr Bioharness Physiological Monitor during the completion of the physiological tests. The Polar HRM

was worn across the chest superior to the pectoral muscles and inferior to the clavicles. The Zephyr Bioharness was worn inferior to the pectoral muscles. The contact areas of both of the devices were moistened with water before the initiation of the tests.

While the objective of testing the participants was to determine their physiological response to set workloads, the safety of the athletes/ participants was the first consideration. Therefore, if it was determined that completing the test would reduce an athlete's ability to participate in practices or competitions, they were not tested. When it was deemed by a member of the research team that it was not safe for the participant/ athlete to continue, the test was stopped. When possible, any testing sessions not started or completed were rescheduled.

Sub-maximal effort treadmill protocols

In order to determine the physiological response to given workloads and to determine the lactate threshold (LT) for each study participant/ athlete treadmill-based sub-maximal effort tests were conducted. The incline of the treadmill was set at 1% for all stages of the sub-maximal effort test to simulate wind-resistance (79). An increase in speed was the only means of increasing difficulty used during the test.

Each stage during the test lasted for 6 min. The duration of the stage was set at 6 min because steady-state in the variables of interest is achieved by 5 min at pre-LT intensities, and thus the sixth minute was used for collection of stage-representative data (88).

Heart rate values were recorded from both the Polar HRM and the Zephyr Bioharness every minute. Just after the start of the fifth minute of each stage, participants were asked to rate the difficulty of the stage using the mCR-10 RPE scale (Table 2.1). A blood

sample was then drawn from a lanced fingertip for [HLA] determination. The participant was then asked if they could continue. If they indicated that they could continue, the speed was increased. A test ended when it was deemed that it was no longer safe for the participant to continue or if the participant indicated either verbally or by a gesture that they did not wish to continue.

The tests conducted with the women's soccer team started at a speed which elicited a HR response of approximately $140 \text{ beats} \cdot \text{min}^{-1}$. Speed was increased by $0.8 \text{ km} \cdot \text{h}^{-1}$ (see Table 2.2). The test was revised for the data collection with the men's soccer team (see Table 2.3). This sub-maximal effort test had a set starting point. The minimum data required for this study was obtained by having participants run until LT. Lactate threshold was indicated by an increase in $[\text{HLA}] \geq 1 \text{ mmol} \cdot \text{l}^{-1}$ from the [HLA] value of the previous stage and a value $>4 \text{ mmol} \cdot \text{l}^{-1}$. Participants willing to continue past LT were allowed to do so, data gathered beyond LT was used in the construction of the [HLA]-HR curve.

Due to the difference in starting speeds between-participant statistical analyses were not possible for the data from the women's team. Therefore, a submaximal protocol using a standardized starting speed was used with the men's team. If a sub-maximal effort test started at a speed that was too slow and did not progress quickly enough, the test could last for an inordinate amount of time. Previous experience has lead to the determination that athletes who were not engaged in running sports prefer not to run longer than 36 min. Therefore, the change of speed between stages was also re-evaluated. Starting at $6.0 \text{ km} \cdot \text{h}^{-1}$ was chosen as it is a brisk walk and $8.0 \text{ km} \cdot \text{h}^{-1}$ is a light jog for most of the athletes/ participants. Increasing the speed by $2.0 \text{ km} \cdot \text{h}^{-1}$

between stages led pilot tests to be completed within 36 min and for LT to be identified easily.

Table 2.2. Sub-maximal effort protocol – variable start

Start	End	Incline (%)	Speed (km • h ⁻¹)	Speed (mi • h ⁻¹)
0:00	6:00	1	Starting HR ~140 beats • min ⁻¹	Starting HR ~140 beats • min ⁻¹
6:00	12:00	1	+0.80/ stage	+0.5/ stage
12:00	18:00	1	“	“
18:00	24:00	1	“	“
24:00	30:00	1	“	“
30:00	36:00	1	“	“
36:00	42:00	1	“	“
42:00	48:00	1	“	“
48:00	54:00	1	“	“

Table 2.3: Sub-maximal effort protocol – standardized start

Start	End	Incline (%)	Speed (km • h ⁻¹)	Speed (mi • h ⁻¹)
0:00	6:00	1	6.0	3.7
6:00	12:00	1	8.0	5.0
12:00	18:00	1	10.0	6.2
18:00	24:00	1	12.0	7.5
24:00	30:00	1	14.0	8.7
30:00	36:00	1	16.0	9.9
36:00	42:00	1	18.0	11.2
42:00	48:00	1	20.0	12.4
48:00	54:00	1	22.0	13.7

Maximal Effort Treadmill Protocols

Human Performance Laboratory Modified Conconi Treadmill Protocol (HMC10) and

Human Performance Laboratory Modified Conconi Treadmill Protocol (HMC11)

Participants completed a maximal effort test to attain maximal levels of HR, VR, ACT, BP, PKA, ST, and [HLA] values. The Human Performance Laboratory Modified Conconi (HMC10) standardized maximal effort treadmill protocol (Table 2.4) was used

with the women's soccer team and the HMC11 (Table 2.5) was used with the men's soccer team.

Each stage of the test was 60 sec in duration, as the goal was not to obtain a steady-state but rather to allow the participant to put forth an effort which produced maximal physiological responses. Each participant/ athlete supplied an RPE score using the mCR-10 scale 45 sec into each stage. The participants were asked if they could continue at that time as well. If they stated that they could, the test continued. If they indicated that they did not wish to continue or could not continue, the test was stopped. The criterion for the maximal effort test was met, if there was no change in $\dot{V}O_2$ with an increase in workload. If this plateau was not present, then 2 of these 3 criteria needed to be met: a respiration exchange ratio of >1.10 , a blood lactate concentration of >8.0 ml of lactate $\cdot L^{-1}$ of blood after the last stage, an RPE of >9.0 on the Modified-Borg 10 point scale. If the HR_{max} was not obtainable from the laboratory tests, the highest HR from the first week of pre-season training (including a scrimmage and field-testing) was used. It was desired that the test be completed within ten to twelve minutes.

A maximal effort test is meant to assess maximal/ peak values of HR or $\dot{V}O_2$. Pilot testing of the HMC10 protocol with male athletes, specifically those engaged in sports like soccer, revealed that they were able to exceed 12 minutes. To address this situation, the starting speed was increased from $6.0 \text{ km} \cdot \text{h}^{-1}$ to $7.0 \text{ km} \cdot \text{h}^{-1}$ stage. Also, ambulating at $7.0 \text{ km} \cdot \text{h}^{-1}$ was awkward for some participants as it has seemed to be a threshold speed for the transition from walking to jogging, therefore reducing the amount time spent at this speed induced less discomfort for the participants. Last, this modification

reduced the time to complete the test from a high of 13 minutes to 11 minutes, which brought the conclusion of the test back into the desirable range of 10 to 12 minutes.

Table 2.4. Human Performance Laboratory modified-Conconi maximal effort treadmill protocol (HMC10)

Start	End	Incline (%)	Speed (km • h ⁻¹)	Speed (mi • h ⁻¹)
0:00	1:00	0	6.0	3.7
1:00	2:00	0	7.0	4.4
2:00	3:00	2	7.0	4.4
3:00	4:00	2	8.0	5.0
4:00	5:00	4	8.0	5.0
5:00	6:00	4	9.0	5.6
6:00	7:00	6	9.0	5.6
7:00	8:00	6	10.0	6.2
8:00	9:00	8	10.0	6.2
9:00	10:00	8	11.0	6.8
10:00	11:00	10	11.0	6.8
11:00	12:00	10	12.0	7.5
12:00	13:00	12	12.0	7.5
13:00	14:00	12	13.0	8.1

Table 2.5. Human Performance Laboratory modified-Conconi maximal effort treadmill protocol (HMC11)

Start	End	Incline (%)	Speed (km • h ⁻¹)	Speed (mi • h ⁻¹)
0:00	1:00	0	7.0	4.4
1:00	2:00	0	8.0	5.0
2:00	3:00	2	8.0	5.0
3:00	4:00	2	9.0	5.6
4:00	5:00	4	9.0	5.6
5:00	6:00	4	10.0	6.2
6:00	7:00	6	10.0	6.2
7:00	8:00	6	11.0	6.8
8:00	9:00	8	11.0	6.8
9:00	10:00	8	12.0	7.5
10:00	11:00	10	12.0	7.5
11:00	12:00	10	13.0	8.1
12:00	13:00	12	13.0	8.1
13:00	14:00	12	14.0	8.7

PLQscore generation

The PLQ models were constructed using the respective [HLA] curves and the sampling rate of the device (Equation 2.4 and 2.5). The best-fit regression formulae to predict [HLA] for the female ($p[HLA]_{WS}$) and the male players ($p[HLA]_{MS}$) was used as the basis for the PLQ score. $p[HLA]_{WSi}$ is the individual product of the $p[HLA]_{WS}$ equation for the female participants, and $p[HLA]_{MSi}$ is the individual product of the $p[HLA]_{MS}$ equation for the male participants. “sr” was the sampling rate of the device being used to collect the data, as expressed in the number of values reported in 1 min. The $[HLA]_{WSi}$ and $[HLA]_{MSi}$ scores were divided by “sr” to present the data as a “per min” value. This division also allowed for the formula to be used if different devices were used to collect the HR data.

$$PLQ_{WS} = \sum(p[HLA]_{WSi} \cdot sr^{-1}) \quad 2.4$$

$$PLQ_{MS} = \sum(p[HLA]_{MSi} \cdot sr^{-1}) \quad 2.5$$

Methods of Analyses

Data

Individual data were presented as absolute number. Group data were presented as mean \pm standard deviation ($\bar{x} \pm s$) values.

Model generation

Univariate and multivariate regression analyses using both linear and non-linear models were used. Root mean square error (RMSE), the coefficient of determination (R^2) and the observed p-values from the regression equations were used to determine the best model. Minitab (version 16) was used to conduct these analyses.

Comparison of TRIMP values from the different models

Test of significance

A paired-sample t-test to compare the PLQ_{WS} and PLQ_{MS} scores was run using SPSS.

A repeated measures analysis of variance (RM-ANOVA) with pair-wise follow-up dependent t-tests using a Bonferroni adjustment was conducted to determine if the PLQ_{WS} scores and PLQ_{MS} scores differed from the scores produced by the previously established models, when all scores were generated from the same dataset.

Assessments of relationship

Pearson's product moment correlations (r) were conducted to determine the level of relationship between 1) the PLQ_{WS} and PLQ_{MS} scores from their respective sub-maximal effort tests, 2) the respective PLQ scores and the relevant $\dot{V}O_2$ values, and 3) the respective PLQ scores and the TRIMP scores produced from the previously established equations.

The coefficient of determination (R^2) was generated to determine the level of relationship between the PLQ scores and physiological values for all sub-maximal effort tests in the determination of the PLQ models.

Interpretation of the r and R^2 values will be made in accordance with the scheme as presented below (48):

Table 2.6. Pearson product-moment correlation (r) and coefficient of determination (R^2) interpretation .

Strength of relationship	r	R^2
Very weak	0 - .19	(0 to 4%)
Weak	.20 - .39	(4 to 16%)
Moderate	.40 - .59	(16 to 36%)
Strong	.60 - .79	(36% to 64%)
Very strong	.80 - 1.00	(64% to 100%)

Assessment of agreement

Bland-Altman plots were constructed to visually assess the level of agreement between the actual and the predicted $\dot{V}O_2$ values at each stage of the sub-maximal effort test for both the PLQ_{WS} and PLQ_{MS} models.

Level of Significance

The level of significance was set at 0.05 ($p < 0.05$) for all analyses and was used to assess difference between the PLQ scores and the scores produced by the previously established models.

SECTION 3: Studies

Study 1: Assessment of Multiple Physiological Variables for Use in the Quantification of Physiological Load

Robert W. Wilson, II¹, Thomas S. Goepfinger², Bruce A Wade², and Ann C. Snyder¹

¹ College of Health Sciences, University of Wisconsin – Milwaukee, Milwaukee, WI; ² Department of Mathematical Sciences, University of Wisconsin – Milwaukee, Milwaukee, WI

Keywords: TRIMPs, training load, soccer, heart rate, mathematical models

Abstract

Proper assessment of the physiological load (PL) of training and competition sessions will help coaches determine when players need rest and may help researchers better understand overreaching and overtraining. Recent technological advances allow for the measurement of variables, which may enhance the predictive ability of PL models obtained in the field. **PURPOSE:** To construct and compare models for the assessment of PL for collegiate soccer players using newly available variables (i.e., accelerometry data, ventilation-rate, skin temperature, body position, etc.). **METHODS:** Data from female and male ($n = 22$, $n = 18$, respectively) well-trained NCAA DI soccer players were used to construct models to assess the quantity of PL (PLQ). Multivariate linear and univariate linear and non-linear regression analyses were conducted to the model for the female (PLQ_{WS}) and male (PLQ_{MS}) participants. **RESULTS:** The best-fit equations were exponential and included only percent of heart rate reserve (%HRR) as a predictor [PLQ_{WS} = $\sum[(0.90886 + 0.00705673 \cdot e^{(7.03434 \cdot \%HRRi)}) \cdot sr^{-1}]$, Root-Mean-Square Error (RMSE) = 1.32108, $p < 0.001$; PLQ_{MS} = $\sum[(0.235182 \cdot e^{(3.55248 \cdot \%HRRi)}) \cdot sr^{-1}]$, RMSE = 1.30449, $p < 0.001$). The models were statistically different but very strongly correlated ($t = -27.62$, $p < 0.001$; $r = 0.98$, $p < 0.00$, respectively). **CONCLUSION:** Of the variables studied, %HRR produces the most accurate models for determining the PL of male and female soccer players. The scores from the PLQ models were statistically different indicating that the models are unique.

Keywords: TRIMPs, training load, soccer, heart rate, mathematical models

INTRODUCTION

Coaches adjust the intensity and volume of practice sessions in order for their athletes to attain peak performance. Periodization advocates that this is accomplished by adjusting the training load (TL) through changing the volume and/ or the intensity of the physical work performed. The periodized plan is a prescription of load; as such it does not provide a measure of each individual's internal physiological load (PL). Several methods have been proposed to calculate PL in a field setting using heart rate (HR).

Football (or soccer) is a stochastic sport requiring participants to engage in activities which vary in intensity during training sessions (13, 44, 59, 86) and competitions (13, 29, 44, 59, 109). To track and/ or evaluate the physiological response of well-trained soccer players during competitions blood lactate ([HLa]) (13, 44), muscle glycogen kinetics (77, 87), and HR (13, 32, 44, 45, 68, 139, 140) have been proposed as measures of intensity. Oxygen uptake ($\dot{V}O_2$) has also been assessed during training sessions. Of these measures, only HR and $\dot{V}O_2$ can be measured continuously. At present, the equipment required to measure $\dot{V}O_2$ prohibits its use in a match. Therefore, to continuously measure the physiological response during practices and competitions, HR has been the only variable available.

Working on a methodology to predict performance in competition from training sessions, Banister and colleagues (15) proposed a mathematical model for calculating the training stress (or TL). This research led to the development of a model for the quantification of the strain (or PL) using HR. The training impulse (TRIMP) score for a training session or competition was the product of the mean of 3 percentage of maximal HR ($\%HR_{max}$) values by the duration of the event. Bannister and colleagues proposed an

alternative model (17) that also multiplied averaged HR values by the duration. Other researchers have developed more complicated and sophisticated models. Lucia and colleagues (96) created a 3-zone model distinguished by ventilatory thresholds. Other researchers have proposed models which establish 5-zones (43, 137, 157). The zone models compute a TRIMP/ PL score by multiplying the amount of time spent in a given zone by the weighting factor for that zone and then summing these products from each zone. The zone models differ on the criteria used to create the zones and the weighting factors for each zone. Some models (63, 98, 107) have been established that weight each transformed HR value (i.e., $\%HR_{\max}$ or percent of heart rate reserve ($\%HRR$)).

The TRIMP_{mod} model (98) was designed for use with a team of male field hockey players. Unlike all other proposed models, the TRIMP_{mod} model was generated from the physiological testing data from all of the players tested.

Recent technological advances have created devices that now allow for additional objective variables, such as ventilation rate (VR), activity (ACT), skin temperature (ST), body posture (BP), and peak acceleration (PkA), to be collected in addition to heart rate variables in a continuous manner in a field setting. These newly available variables and/or their interaction may enhance the assessment of PL. These devices have yet to be used in the determination of PLs during practices and competitions.

Objectives This study had three objectives. The first objective was to employ continuously sampled variables which can be attained in a field setting to generate the mathematical model for the quantification of the PL (PLQ). The model for the female players (PLQ_{WS}) was generated using the data from the female collegiate soccer players' sub-maximal and maximal effort tests. We hypothesized that a multiple variable

equation would produce a better fit regression equation, as indicated by a lower root mean squared error (RMSE) and/ or higher coefficient of determination (R^2) value. We further hypothesized that using %HRR with VR and/ or ACT would produce a better fit equation than using %HRR alone. This hypothesis was based on the knowledge that as exercise intensity increases, the VR and the amount of movement/ force produced by the body increases as well. Therefore, it was expected that the interaction between movement (as measured by the ACT value), the VR and %HRR combined would be a more sensitive measure of physiological load.

The second objective was to generate a similar model for male collegiate soccer players (PLQ_{MS}) using the same dependent variable(s) used in the PLQ_{WS} model using data from their sub-maximal and maximal effort tests.

The third objective of this study was to compare the two models to determine how similar and related they were. Due to the typical differences in fitness levels and muscularity between female and male collegiate soccer players (73), and the differences in training and competition strategies typically employed by coaches at this competition level, it was hypothesized that the PLQ_{MS} model would produce a lower score than the PLQ_{WS} model for the same bout of exercise and that the scores would be strongly related but statistically different for the same exercise bout.

METHODS

Participants Women's (n=22) and men's (n=18) football/soccer team members from a very competitive National Collegiate Athletic Association (NCAA) Division 1 (DI) university served as participants in this study. Participant characteristics are shown in

Table 3.1.1. Team members who enrolled in the study and were deemed to be free from conditions which could be aggravated by participation in the study were enrolled as participants. Two female players were excluded due to pre-existing conditions which would have been aggravated by completing the testing. This study was approved by the Institutional Review Board at the University of Wisconsin – Milwaukee. All team members completed the approved Informed Consent Document and Health History Questionnaire prior to the initiation of the study. Consent was sought and obtained from the parent or legal guardian and assent was obtained from the minor for study participants under the age of eighteen years.

Table 3.1.1. Demographic data for players used to generate PLQ_{WS} and PLQ_{MS} models

		Age (yr)	Height (m)	Weight (kg)	BMI (kg • m ⁻²)
Women	$\bar{x} \pm s$	19.5 ± 1.1	1.67 ± 0.06	61.62 ± 6.14	22.19 ± 1.73
(n = 22)	(max – min)	(22 – 18)	(1.8 – 1.6)	(71.8 – 50.0)	(25.2 – 19.3)
Men	$\bar{x} \pm s$	19.5 ± 1.6	1.80 ± 0.08	76.13 ± 10.31	23.40 ± 1.96
(n = 18)	(max – min)	(23 – 17)	(1.9 – 1.7)	(104.5 – 62.7)	(29.6 – 20.5)

	Goalkeepers	Defenders	Midfielders	Forwards	Utility*
Women (n = 22)	0	3	9	4	6
Men (n = 18)	0	7	5	0	6

* Utility denotes players who play more than one position.

Study Design This study was completed in three phases.

Phase 1: Participants were brought into the Human Performance Lab to complete sub-maximal and maximal effort tests on a treadmill either prior to the start of their pre-season training for the competitive season or during an off-week in the middle of season. Female athletes tested in the middle of the season had one off-day and two days of light training prior to testing. Blood was sampled and analyzed during all tests for the lactate concentration, which was used as the indicator of the intensity of the work performed and

the outcome variable in the model development. Blood lactate concentration was the chosen measure of work performed instead of $\dot{V}O_2$. In order to obtain work performed from $\dot{V}O_2$, data would have to be obtained during the bout of exercise and while this is possible in a laboratory setting it is not feasible in a field setting (i.e., practice and competition session). The predictor variables (HR, %HR_{max}, VR, ACT, BP, PkA, and ST) were collected using the Zephyr Bioharness Physiological Status Monitor (Zephyr Technologies, Inc., Auckland, New Zealand). %HRR was calculated during data analysis (81).

Phase 2: To produce the predictive model, data from the female participants were pooled and analyzed as a group to determine the best-fit regression equations using multivariate linear techniques and univariate non-linear techniques. The best fitting equation was termed p[HLa]_{WS}. The predictor variable from which produced the best-fit equation from the p[HLa]_{WS} equations was used to generate the p[HLa]_{MS} equations. Next, the PLQ_{WS} and PLQ_{MS} models were constructed as the sum of all values generated by entering the selected values in to the p[HLa]_{WS} and p[HLa]_{MS} equations, and then dividing them by the sampling rate of the device used to collect the physiological data which expresses the PLQ score as a PLQ • min⁻¹ value.

Phase 3: Lastly, %HRR data from a single women's practice session were entered into the PLQ_{WS} and the PLQ_{MS} models to produce the PLQ scores for each player. These scores were then analyzed to determine how the two models relate to each other.

Equipment Treadmill: A Woodway Desmo slatted treadmill (Woodway USA, Inc., Waukesha, WI) with a speed range of 0.1 – 24.3 km • h⁻¹ and an incline range of 0.1 –

14.4 % was used for all tests. Speed and incline were controlled through an external control panel by a member of the research team.

Lactate Analyzers: For analysis of the blood samples from the female participants, a YSI Sport1500 Lactate Analyzer (YSI, Yellow Springs, OH) was used to measure the concentration of blood lactate in a 50 μ l blood sample. Each sample was hemolyzed in 100 μ l of buffer (Buffer: 10.0 ml stock buffer solution + 0.44 ml Triton X-100 detergent + 50 g Sodium Fluoride (NaF) Anhydrous MW 42.0). This analysis process has been shown to be valid and reliable (2, 22, 103, 105, 152). For the male participants, a Lactate Pro Analyzer (Arkray Factory Inc., KDK Corporation, Shiga, Japan) measured the concentration of lactate in a sample (approximately 5 μ l) of whole blood which was drawn into the sensor strip. This process has been shown to be valid and reliable (103, 105, 122, 145). The two methods used to determine [HLA] have been shown to produce equivalent results (103).

Monitors: The Zephyr Bioharness Physiological Monitoring System (Zephyr Technologies, Inc., Auckland, New Zealand) was used to collect HR, %HR_{max}, VR, ACT, BP, PkA and ST. Data was viewed during testing using the OmniSense Live (Zephyr Technologies, Inc.) software program during the tests and then exported using the OmniSense Analysis (Zephyr Technologies, Inc.) software program to Microsoft Excel (Microsoft Corporation, Redmond, WA USA) for data screening and re-formatting. Polar Team1 HR Monitors (Polar Electro, Oy, Kempele Finland) collected and stored HR values averaged over a 5 sec epoch. This methodology has been shown to be valid and reliable for the *in situ* determination of HR (131, 149). Stored HR data was downloaded

to the Polar ProTrainer 5 (version 5.00.100) software and then exported to Microsoft Excel for data screening and re-formatting. The data is presented as five-sec averages.

Variables The Zephyr Bioharness provides the following data: HR, %HR_{max}, VR, ACT, BP, ST, and PkA. Sampling and reporting rates and data range information is reported in Table 3.1.2. Heart rate, the number of beats of the heart in a minute, was measured by detecting the R-R wave interval. Ventilation rate, the number of breathes per minute, was measured by the movement of a strain gauge in the elastic strap. The clip-on module contains a non-gyroscopically controlled tri-axial solid-state accelerometer. Activity, a measurement of the intensity of the body's movement, was the summation of the magnitude of the movement in the three vectors. Peak Acceleration, a measurement of peak activity, was the maximum magnitude from the three-axes achieved during the previous 1 sec epoch. Position, the anterior or posterior tilt of the upper torso, was measured by the change in position of the tri-axial accelerometer. Skin temperature, the measure of the radiating heat from the center of the chest, was determined using a near-infrared sensor in the Zephyr Bioharness clip-on module.

Table 3.1.2. Sampling and reporting information for Zephyr Bioharness variables

Variable	Sampling rate	Reporting rate	Range
HR	~1 Hz	~1 Hz	30 – 240 beats • min ⁻¹
VR	~18 Hz	~1 Hz	3 – 70 breaths • min ⁻¹
BP	~1 Hz	~1 Hz	-90 – 90 °
ST	~1 Hz	~1 Hz	10 – 60 °C
ACT	~18 Hz	~1 Hz	0 – 5.7 VMU in g sec
PkA	~18 Hz	~1 Hz	0 – 5.7 g

~1 Hz = 1.008 sec; ~18 Hz = 0.056 sec; ° = measure of movement from vertical; °C = degrees Celsius; VMU = vector magnitude unit; g = gravitational force.

The %HR_{max} variable was calculated using the formula in Equation 3.1.1 (75, 127).

$$\%HR_{\max} = HR_{\text{obs}} \cdot HR_{\max}^{-1} \quad 3.1.1$$

Where “HR_{obs}” was the heart rate data point of interest and “HR_{max}” was the maximum heart rate as determined by the Inbar formula (Equation 3.1.2).

$$HR_{\max} = 205.8 - (0.685 \cdot \text{age}) \quad 3.1.2$$

Where “age” was the age of the participant/ athlete in whole years.

Compared to %HR_{max}, %HRR was a more sensitive measure of heart rate (82). To calculate %HRR the resting (or basal) HR (HR_{rest}) value was subtracted from the numerator and denominator values of the HR_{max} equation thus reducing the ranges of numerator and denominator to realistic spans (Equation 3.1.3).

$$\%HRR = (HR_{\text{obs}} - HR_{\text{rest}}) \cdot (HR_{\max} - HR_{\text{rest}})^{-1} \quad 3.1.3$$

It was not possible to obtain HR_{rest} values, hence it was substituted the lowest HR (HR_{low}) value recorded while wearing the HRM during either the pre-season testing session or the first week of practices (Table 3.1.3). The HR_{low} values for our female athletes were lower than the referent general population sample’s HR_{rest} values (73). The referent sample included athletes and non-athlete and individual older than our sample. The HR_{low} values for the male athletes appear to be equivalent to the referent general population sample’s HR_{rest} values.

Table 3.1.3 Resting heart rates (HR_{rest}) for 20-29 year old individuals (73) and low heart rates (HR_{low}) for study participants

		HR _{rest} (beats • min ⁻¹)	HR _{low} (beats • min ⁻¹)
Women	$\bar{x} \pm s$	67 ± 11.2	58 ± 7.0
	(max – min)	84 – 55	70 – 44
Men	$\bar{x} \pm s$	64 ± 12.5	61.3 ± 6.0
	(max – min)	80 – 50	76 – 53

Observed HR (HR_{obs}) were the HR values of interest from the testing sessions. The maximum HR (HR_{max}) was determined from the maximal effort test that the participant/athlete performed. Thus, the equation used is below (Equation 3.1.4).

$$\%HRR = (HR_{obs} - HR_{low}) \cdot (HR_{max} - HR_{low})^{-1} \quad 3.1.4$$

Physiological Tests The protocols for the physiological tests are presented in Table 3.1.4 and Table 3.1.5; female participants completed the “Variable start” sub-maximal protocol and the Human Performance Laboratory Modified Conconi maximal effort test (HMC10). Pilot tests conducted before the male participants were tested indicated that the protocols needed to be modified so the sub-maximal and maximal effort tests would conclude in ~30 min and between 10 and 12 min, respectively. Therefore, male participants completed the “Standardized start” sub-maximal protocol and the HMC11 protocol. Blood was sampled during the 5th min of each sub-maximal stage and 1 min after the conclusion of the maximal test for the determination of [HLA].

Table 3.1.4. Sub-maximal effort treadmill protocols

Start	End	Incline (%)	Variable start Speed ($km \cdot h^{-1}$)	Standardized start Speed ($km \cdot h^{-1}$)
0:00	6:00	1	Starting HR ~140 bpm	6.0
6:00	12:00	1	+0.80/ stage	8.0
12:00	18:00	1	“	10.0
18:00	24:00	1	“	12.0
24:00	30:00	1	“	14.0
30:00	36:00	1	“	16.0
36:00	42:00	1	“	18.0
42:00	48:00	1	“	20.0
48:00	54:00	1	“	22.0

Table 3.1.5. Human Performance Laboratory modified-Conconi maximal effort treadmill protocols (HMC10 and HMC11)

Start	End	Incline (%)	HMC10	HMC11
			Speed (km • h ⁻¹)	Speed (km • h ⁻¹)
0:00	1:00	0	6.0	7.0
1:00	2:00	0	7.0	8.0
2:00	3:00	2	7.0	8.0
3:00	4:00	2	8.0	9.0
4:00	5:00	4	8.0	9.0
5:00	6:00	4	9.0	10.0
6:00	7:00	6	9.0	10.0
7:00	8:00	6	10.0	11.0
8:00	9:00	8	10.0	11.0
9:00	10:00	8	11.0	12.0
10:00	11:00	10	11.0	12.0
11:00	12:00	10	12.0	13.0
12:00	13:00	12	12.0	13.0
13:00	14:00	12	13.0	14.0

Analyses Microsoft Excel was used to review and organize the data for analysis in the statistical software packages, and to construct the Bland-Altman Plots. Minitab (version 16, Minitab Inc., State College, PA USA) was used to conduct the univariate non-linear and multivariate linear regression analyses to generate the p[HLa]_{WS} equation, which is the basis of the PLQ_{WS} model and then the PLQ_{MS} model using predictor and outcome variable combinations from the PLQ_{WS} model. Statistics reported from the model generations are the root mean square error (RMSE), the coefficient of determination (R^2), and the observed p-value. The RMSE was the average distance the observed data values fall from the fitted regression values. The R^2 values for exponential equations were calculated by IBM SPSS Statistics (v19) (International Business Machines Corp., Armonk, New York USA).

A paired-sample t-test to compare the PLQ_{WS} and PLQ_{MS} scores and a Pearson's product moment correlation (r) to determine the degree of relationship between the PLQ_{WS} and PLQ_{MS} scores were run using SPSS.

Interpretation of r and R² values were made using the criteria proposed by Evans (48).

The level of significance was set at 0.05 (p < 0.05) for all analyses.

RESULTS

Phase 1 Data for the %HRR, %HR_{max}, HR, VR, ACT, ST, BP, and PkA variables from the sub-maximal and maximal effort test of the female participants are individually graphed against [HLA] data in Figure 3.1.1a – 3.1.1h. Non-linear relationships were apparent in the %HRR, %HR_{max}, and HR graphs. The data in the VR, ACT, ST, BP and PkA graphs do not appear to have strong linear or non-linear relationships. (Analysis of the data is presented in Phase 2.)

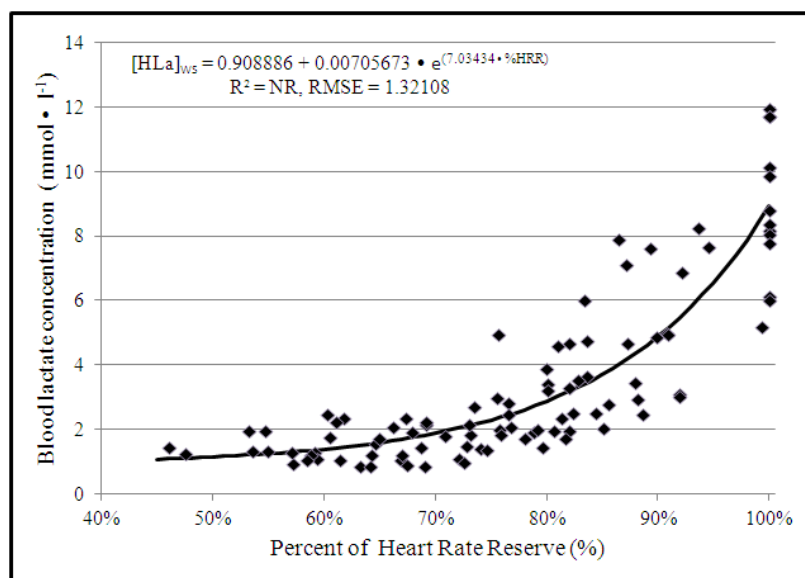

Figure 3.1.1a. Scatterplot of %HRR data against [HLA] data from sub-maximal and maximal effort tests

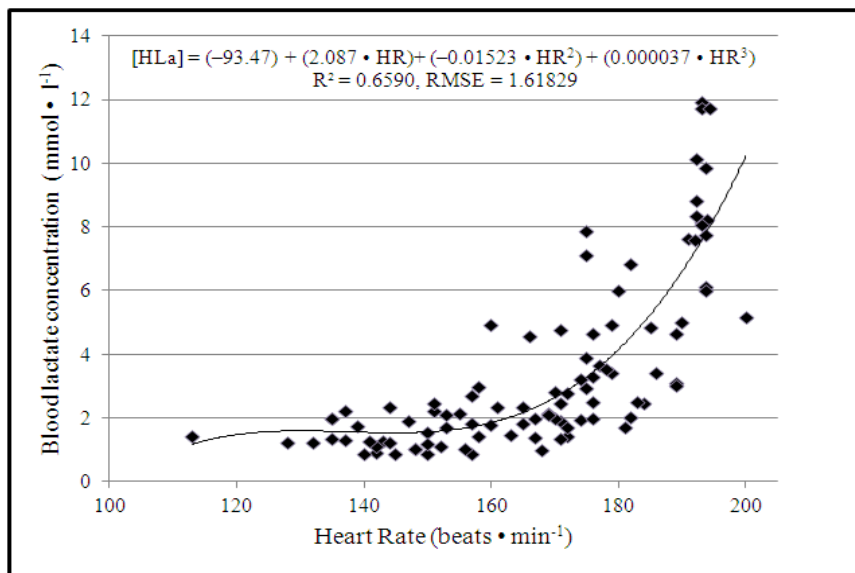

Figure 3.1.1b. Scatterplot of HR data against [HLA] data from sub-maximal and maximal effort tests

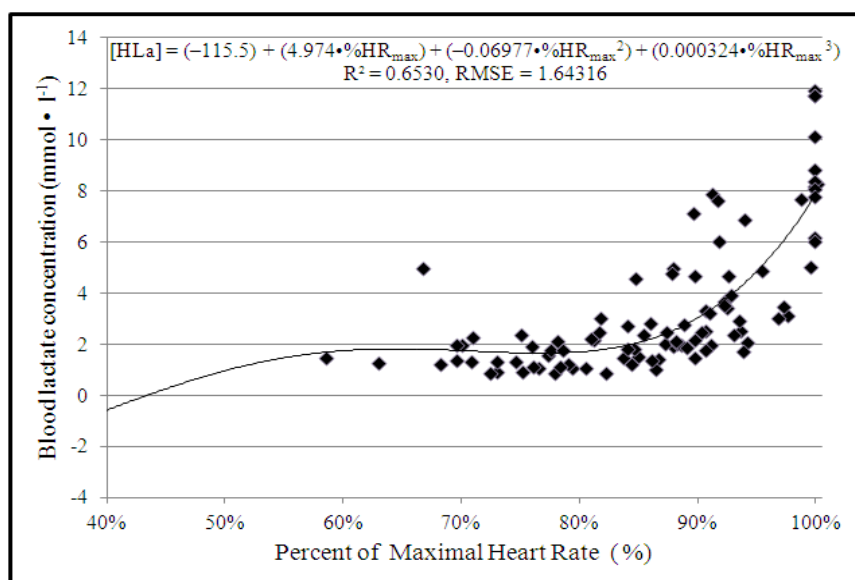

Figure 3.1.1c. Scatterplot of %HR_{max} data against [HLA] data from sub-maximal and maximal effort tests

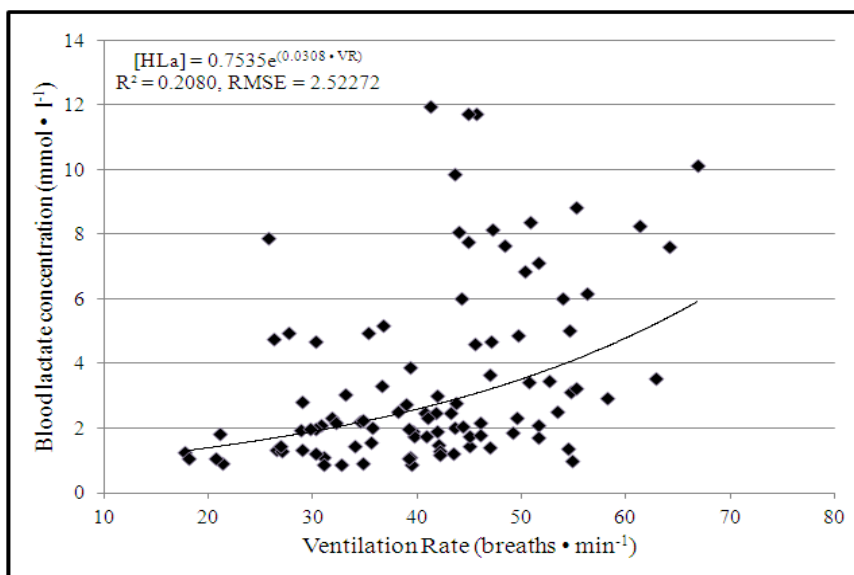

Figure 3.1.1d. Scatterplot of VR data against [HLa] data from sub-maximal and maximal effort tests

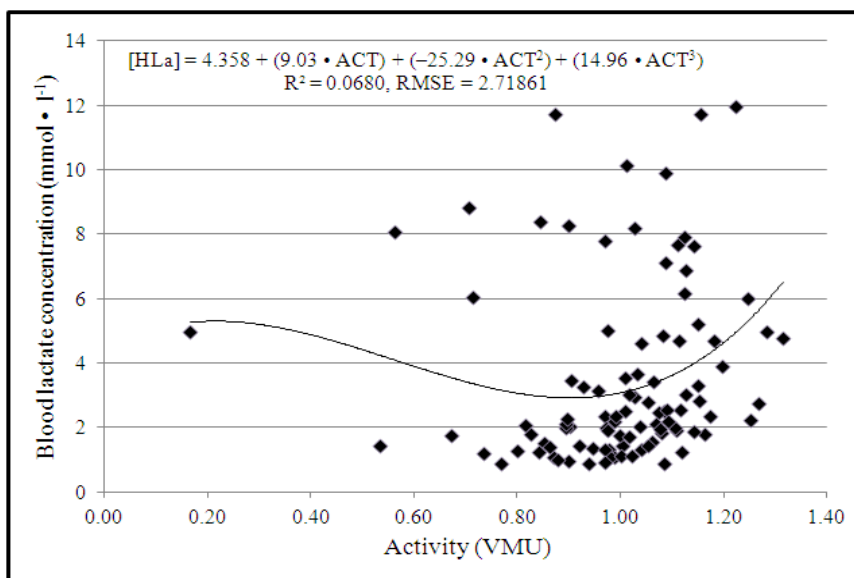

Figure 3.1.1e. Scatterplot of ACT data against [HLa] data from sub-maximal and maximal effort tests

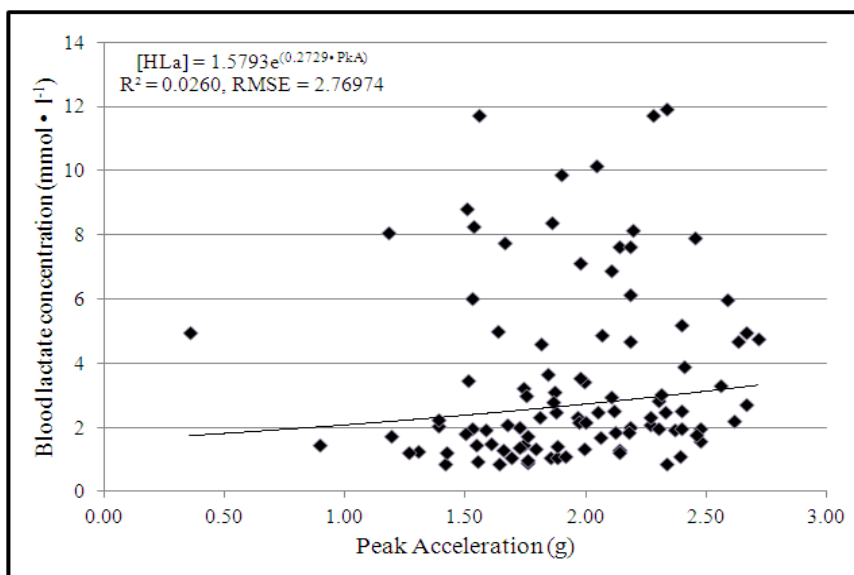

Figure 3.1.1f . Scatterplot of PkA data against [HLA] data from sub-maximal and maximal effort tests.

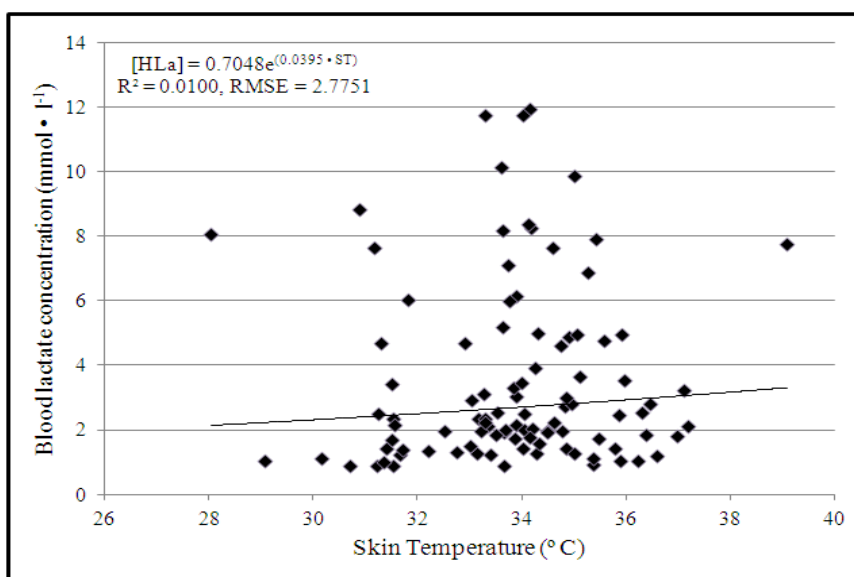

Figure 3.1.1g. Scatterplot of ST data against [HLA] data from sub-maximal and maximal effort tests.

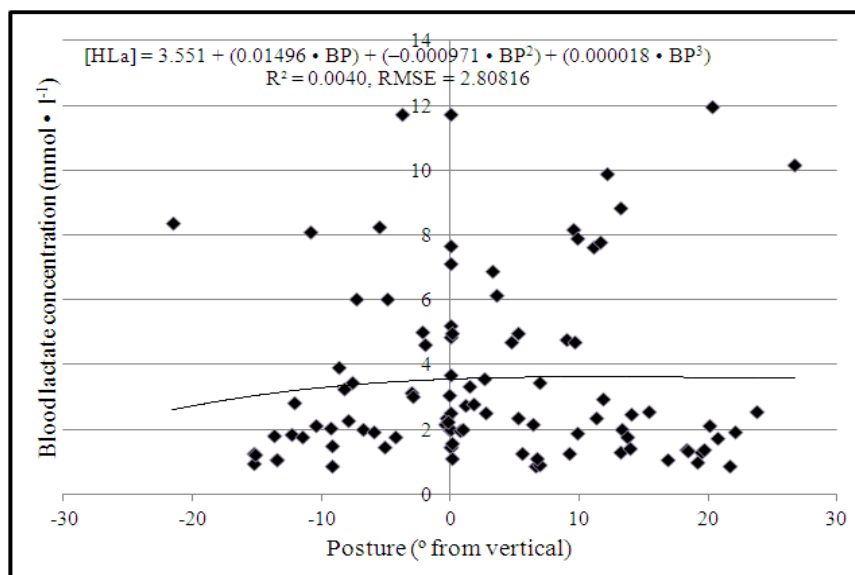

Figure 3.1.1h. Scatterplot of BP data against [HLA] data from sub-maximal and maximal effort tests.

Phase 2 Minitab (v16) returned the best-fit equation for the multivariate linear regression analyses and the 4 types of univariate (linear, quadratic, cubic and exponential). The best-fit equation (i.e., the lowest RMSE) was a univariate model that utilized the %HRR as the predictor variable of [HLA] in the exponential form (Table 3.1.7) not a multivariate model as had been hypothesized. The RMSE measured the distance between the curve and the observed data. Therefore, lower RMSE values indicate a line with less error. Due to the facts that the best-fit equation was a univariate equation and the number of multivariate analyses conducted, only those multivariate regressions analyses related to the hypotheses are presented (Table 3.1.6). The regression equations for the best-fit multivariate analyses are presented in Table 3.1.6, and the regression equations for best-fit are presented in the respective figures (Figure 3.1.1a – 3.1.1h).

Table 3.1.6. Best-fit multivariate linear regression equations for the p[HLA]_{WS} models.

Equation	RMSE	R ²
[HLA] = (-8.21) + (16.5 • %HRR) + (-0.0218 • VR) + (-0.22 • ACT)	1.719	62.7*
[HLA] = (-8.41) + (16.5 • %HRR) + (-0.0212 • VR)	1.710	62.7*
[HLA] = (-8.51) + (15.6 • %HRR) + (-0.06 • ACT)	1.720	62.2*
[HLA] = (-2.78) + (0.108 • VR) + (1.84 • ACT)	2.539	17.7*

* p<0.001

Table 3.1.7. Best-fit univariate p[HLA]_{WS} models for each type of non-linear regression

%HRR	HR	%HR _{max}	VR	ACT	PkA	ST	BP	RMSE	R ²	Equation form
X								1.32108	NR	Exponential
X*								1.32259	0.7780	Cubic
X*								1.33235	0.7730	Quadratic
	X*							1.61829	0.6590	Cubic
		X*						1.64316	0.6530	Cubic
	X*							1.65438	0.6510	Quadratic
	X*							NR	0.6010	Exponential
		X*						1.69592	0.5650	Quadratic
			X*					2.52272	0.2080	Exponential
			X*					2.55724	0.1740	Cubic
			X*					2.54636	0.1720	Quadratic
		X*						NR	0.1630	Exponential
				X				2.71861	0.0680	Cubic
				X				2.72023	0.0560	Quadratic
					X			2.76974	0.0260	Exponential
				X				NR	0.0240	Exponential
					X			2.78852	0.0180	Cubic
					X			2.78078	0.0130	Quadratic
						X		2.7751	0.0100	Exponential
						X		2.80810	0.0020	Cubic
							X	2.80816	0.0040	Cubic
							X	2.79349	0.0040	Quadratic
					X			2.79603	0.0020	Quadratic
						X		NR	0.0000	Exponential

RMSE = root mean squared error ($MSE^{0.5}$), R² = coefficient of determination (calculated by SPSS), Equation form = the type of non-linear regression equation. * p < 0.001, NR = data not reported by the statistical package. Equations are ranked in ascending RMSE and then descending R² values when RMSE are not calculated.

The initial best-fit equation with the lowest RMSE value was produced using only %HRR as the predictor variable in a 3rd degree polynomial equation (p[HLA]_{WS}3p; RMSE

= 1.32259, $p < 0.001$, Figure 3.1.2a). Further analysis revealed that a better fitting model was produced using an asymptotic exponential equation ($p[HLa]_{WS}$; RMSE = 1.32108, $p < 0.001$, Figure 3.1.2b). This asymptotic exponential equation model was chosen as it produced realistic [HLA] values at low %HRR values, while the $p[HLa]_{WS3p}$ produced negative lactate values at less than 21% of HRR. Univariate regression analyses (i.e., linear, quadratic, cubic and exponential) conducted on the male participant's %HRR and [HLA] data produced an exponential best-fit equation ($p[HLa]_{MS}$, RMSE = 1.30449, $p < 0.001$, Figure 3.1.2c).

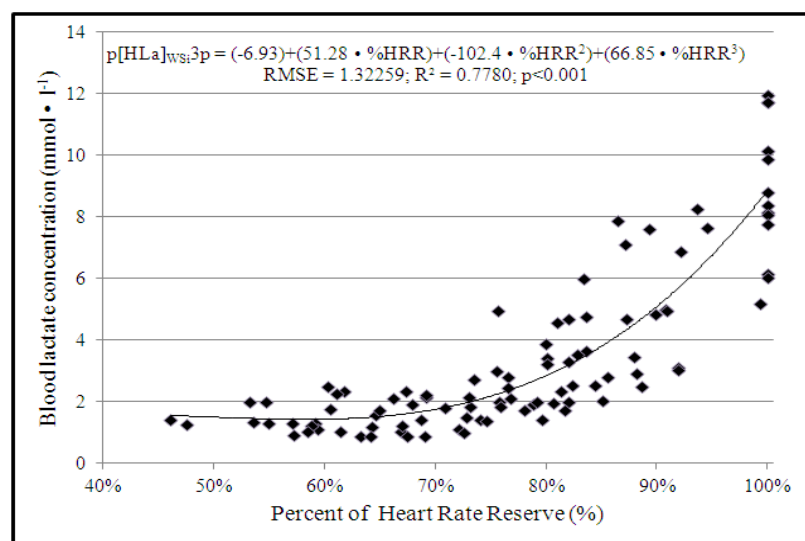

Figure 3.1.2a. Blood lactate concentration ([HLA]) values expressed against the percent of heart rate reserve (%HRR) for the female players. The best-fit curve is the $p[HLa]_{WS3p}$ curve.

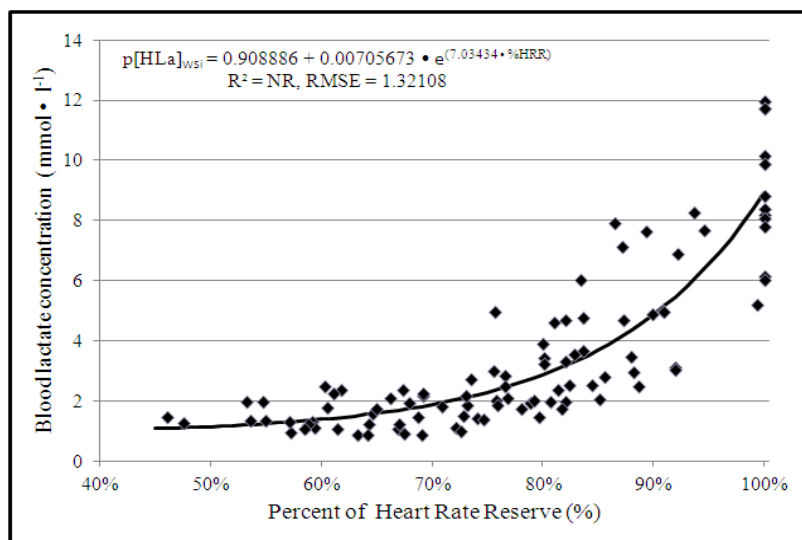

Figure 3.1.2b. Blood lactate concentration ([HLA]) values expressed against the percent of heart rate reserve (%HRR) for the female players. The best-fit curve is the p[HLa]_{WSI} curve.

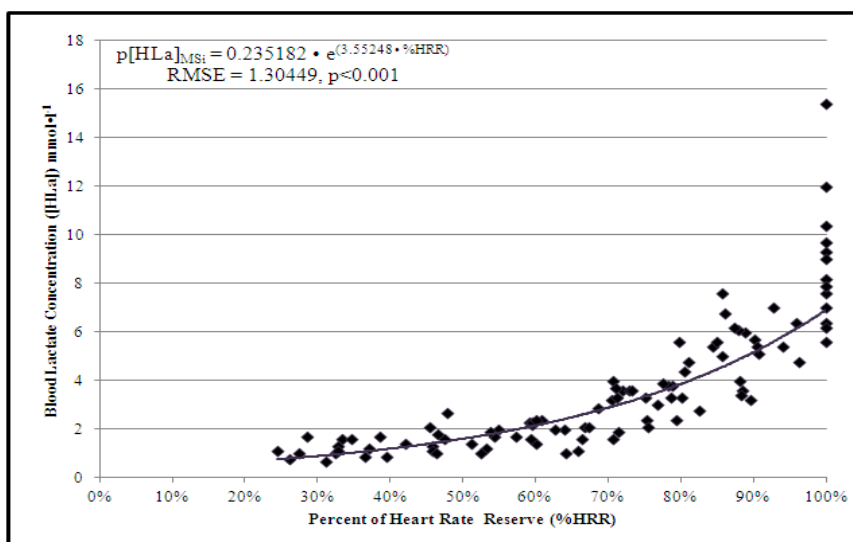

Figure 3.1.2c. Blood lactate concentration ([HLA]) values expressed against the percent of heart rate reserve (%HRR) for the male players. The best-fit curve is the p[HLa]_{MSI} curve.

Phase 3

To calculate a PLQ score, all HR data (expressed as %HRR values) were entered into the chosen p[HLA]_i formulae; for the women the equation is found in Figure 3.1.2b and

for the men the equation is found in Figure 3.1.2c. The resulting values were divided by the sampling rate (sr) of the device and then added together. Therefore, the PLQ score was expressed as a “per minute” (min^{-1}) value. The PLQ formulae are found in equations 3.1.5 and 3.16.

$$\text{PLQ}_{\text{WS}} = \sum [(0.90886 + 0.00705673 \cdot e^{(7.03434 \cdot \% \text{HRR}_i)}) \cdot \text{sr}^{-1}] \quad 3.1.5$$

$$\text{PLQ}_{\text{MS}} = \sum [(0.235182 \cdot e^{(3.55248 \cdot \% \text{HRR}_i)}) \cdot \text{sr}^{-1}] \quad 3.1.6$$

For the randomly selected practice session, twenty-three ($n=23$) women participated in the session (demographic data: Table 3.1.8). Their HR data was transformed to %HRR values. The %HRR values were entered into the PLQ_{WS} and PLQ_{MS} models to produce the PLQ_{WS} and PLQ_{MS} scores (Table 3.1.9).

Table 3.1.8. Demographic data for players used in the comparison of the PLQ_{WS} and PLQ_{MS} models.

		Age (yr)	Height (m)	Weight (kg)	BMI ($\text{kg} \cdot \text{m}^{-2}$)												
Women	$\bar{x} \pm s$	19.5 ± 1.16	1.66 ± 0.06	61.5 ± 5.9	22.3 ± 1.6												
($n = 23$)	(max – min)	22 – 18	1.8 – 1.6	71.8 ± 50.0	25.2 – 19.9												
		<table border="1"> <thead> <tr> <th></th> <th>Goalkeepers</th> <th>Defenders</th> <th>Midfielders</th> <th>Forwards</th> <th>Utility*</th> </tr> </thead> <tbody> <tr> <td>Women ($n = 22$)</td> <td>0</td> <td>4</td> <td>9</td> <td>6</td> <td>4</td> </tr> </tbody> </table>					Goalkeepers	Defenders	Midfielders	Forwards	Utility*	Women ($n = 22$)	0	4	9	6	4
	Goalkeepers	Defenders	Midfielders	Forwards	Utility*												
Women ($n = 22$)	0	4	9	6	4												

* Utility denotes players who play more than one position.

A paired sample t -test indicated that the scores were significantly different ($\bar{x} \pm s$: PLQ_{WS} 242.22 ± 66.85 ; PLQ_{MS} , 318.16 ± 69.22 ; $t = -33.28$; $p < 0.001$). The PLQ scores were very strongly correlated and significantly related ($r = 0.98$; $p < 0.001$; Figure 3.1.3).

Table 3.1.9. Scores generated from the PLQ_{WS} and PLQ_{MS} models.

Participant	PLQ _{WS} Score	PLQ _{MS} Score
1	201.91	284.78
2	198.20	269.53
3	298.18	386.67
4	226.88	280.62
5	256.43	338.67
6	162.56	229.17
7	349.95	429.30
8	188.84	267.05
9	271.79	360.62
10	294.99	374.53
11	231.52	312.27
12	175.40	251.03
13	361.22	440.44
14	235.50	316.56
15	274.21	360.19
16	177.06	246.53
17	235.24	322.37
18	378.09	427.61
19	181.09	254.80
20	215.60	304.67
21	165.95	229.84
22	328.53	407.82
23	161.97	222.64

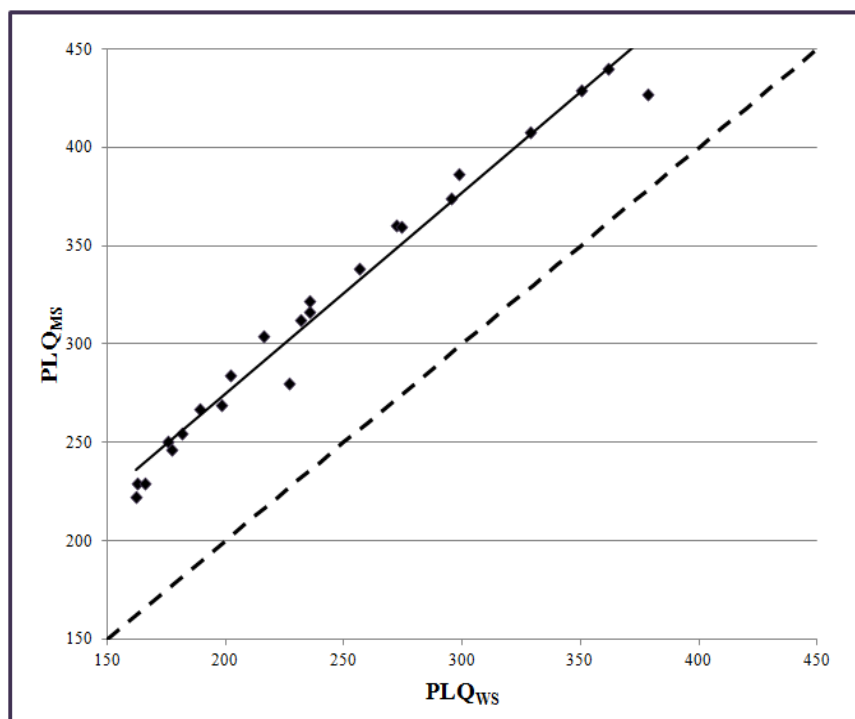

Figure 3.1.3. Scatter plot of PLQ_{WS} scores against PLQ_{MS} scores. The dotted line signifies the line of identity. $PLQ_{MS} = (1.0227 \cdot PLQ_{WS}) + 70.429$

DISCUSSION

The objectives of this study were to assess the utility of variables which can be collected in a continuous manner during sport training sessions for use in the assessment of PL for female and male NCAA DI soccer players and the relationship between the two resulting gender-based models. There are three principle findings from this study. The model with the best-fit PLQ_{WS} equation utilized only %HRR. Therefore, none of the other measured variables, including VR and ACT, added to the predictive ability of the generated models. This finding does not support our hypotheses. The models for the female and male soccer players were different and produced statistically different but very strongly correlated scores. These findings support our hypotheses regarding the two

PLQ models. However, the scores from the PLQ_{MS} model were higher than the scores from the PLQ_{WS} mode, which is contrary to our hypothesis.

Model characteristics Recent technological advances allow sports coaches and scientists to gather more variables in a continuous manner for analysis and use in determination of the physiological strain placed on athletes during practices and competitions. This study indicated that the variables HR, %HR_{max}, ACT, VR, BP, ST, and PkA measured during sub-maximal and maximal effort laboratory treadmill tests do not enhance the ability to predict work (as indicated by [HLA]) over the use of %HRR alone.

The variability of heart rate values between individuals at the same absolute intensity is a well-established phenomenon. The absolute heart rate response depends on several characteristics, which includes health status, fitness level, training mode, age, gender when controlling for the mode and environmental conditions of the test. This higher level of variation in RMSE was observed in Figure 3.1.1c compared to Figure 3.1.1a.

To control for this variability HR can be expressed as a relative measure (i.e., %HR_{max} and %HRR). Percent of HR_{max} was calculated using Inbar and colleagues' formula (75) rather than using a HR_{max} value from the testing or practice sessions and then determining the %HR_{max} values. As one of the purposes of the study was to use the data from the system, the use of this variable even with the potential degree of error was desired. Future studies should incorporate the actual values to calculate %HR_{max}. In the formula for %HRR, the HR_{low} value was subtracted from both the HR value of interest (e.g., HR_{obs}) and the HR_{max} to produce a tighter range and a more sensitive measure of

change. Therefore, the increased degree of error and lower degree of sensitivity of the $\%HR_{max}$ data may account for the slight differences in model fit variables as indicated by higher RMSE values than the $\%HRR$.

p[HLA] equations Small variations between stages were found in the values of the ACT, BP, PkA and ST and when plotted against [HLA] resulted in very weak to moderate coefficients of determination (Table 3.1.7). During exercise, the cardiovascular and circulatory systems work to maintain the body's core temperature. Therefore, it was not surprising to find a minimal variation in ST in an environmentally controlled setting where the individual was able to consume liquids prior to and between tests. The lack of variation in the ACT, BP and PkA data was most likely due to the fact that the tests were conducted on a treadmill, where running occurs primarily in the vertical plane (i.e., up and down) in the same relative position (i.e., upright with minimal forward lean) and with little change in acceleration required except when speed was increased at the start of a stage. It may be possible to enhance the utility of this data by combining laboratory tests with field tests to devise an adjustment that would allow the data on the treadmill to be more accurate.

It was hypothesized that VR would be included in the PLQ model because of the relationship expressed between VR and exercise intensity. In these studies VR was measured using inspired and expired airflow (9, 33, 130). While the VR data obtained in this study does show a linear trend, there were large variations during each stage of the sub-maximal test. We propose two possible explanations for the data. First, it was possible that this chest worn system was not sensitive enough to reliably assess VR. The system determines a ventilatory cycle from a strain gauge in the elastic strap. Previous

research in this laboratory has shown the Bioharness detection of ventilation threshold is correlated with the detection of a portable metabolic cart (154). However, the strain gauge may not have been within the optimal range to provide accurate results due to the strap being too loose or too tight (an issue of operator/ experimenter error). To control for this, the same member of the research team checked the tightness of the elastic strap for each participant but as we did not have an objective measure, the degree of error attributable to the tightness of the strap cannot be determined. As each participant had VR values for all of their tests, we can assert that the monitors were at least operational. A second explanation for the lack of a discernible pattern in the VR data was related to the design of the treadmill protocol. Analysis of the VR data from the Bioharness plotted against [HLA] revealed a trend but a poor correlation of the data due to the high variability along both axes. Efforts were taken to communicate non-verbally with participants during their tests to reduce the potential disruption of VR values. When events that could affect the VR values occurred they were noted for consideration during data screening. These events did not occur during the periods when the observed data were collected.

p[HLA]_{WS} equations It was the intention of the study to develop a model which allowed for all data collected during a exercise event to be incorporated into the PLQ score. The resulting p[HLA]_{WS} equation used %HRR to predict [HLA] and resulted in a 3rd degree polynomial equation (Figure 3.1.2a). The model appears to be logical but testing of the model revealed that HR's of 29.48% HRR (~100 beats • min⁻¹) produce a value of ~1.0 and that the HRs values below 21.35% HRR (~90 beats • min⁻¹) produce a negative value. The continued analysis led to the postulation of an exponential formula

($p[HLa]_{WSi}$) which did not produce a negative score for any values given the asymptotic nature of the equation. The $p[HLa]_{WSi}$ equation has a slightly lower RMSE value than the $p[HLa]_{WSi3p}$ equation (Figure 3.1.2a and 3.1.2b) indicating less variance between the observed data and the regression line.

As we were not able to obtain basal HR values, the actual HR_{rest} value was not used in the equation. In this study we used the HR_{low} value for each player which was determined as the lowest HR value during either their pre-season testing sessions or the first week of training. The HR_{low} values were approximately the same as the referenced HR_{rest} standard which included athletes and non-athletes. Therefore, we may have the same or a slightly smaller HR_{span} value than if we had been able to collect the actual HR_{rest} values. Future research is warranted to determine whether there is a meaningful and statistical difference in %HRR when using HR_{low} value or HR_{rest} value as utilized here.

$p[HLa]_{MSi}$ equation The same set of variables used in the $p[HLa]_{WSi}$ model were used for the determination of the $p[HLa]_{MSi}$ equation (predictor variable: %HRR; outcome variable: [HLA], Figure 3.1.2c). The best-fit equation was an exponential equation using the natural log, similar to previous research (17, 107). However, the $p[HLa]_{MSi}$ equation was based on the data from these individuals.

When entering scores of 0 to 100% into the PLQ_{MS} model all values were positive.

Comparison of the PLQ_{WS} and PLQ_{MS} models The scores from PLQ_{MS} were greater than the scores from PLQ_{WS} (Table 3.1.9, $\bar{x} \pm s$: 318.16 ± 69.22 , 238.07 ± 65.56 , respectively; $p < 0.001$). These scores were very strongly correlated ($r = 0.980$; $p < 0.001$) (Figure 3.1.3). These findings support our hypotheses regarding the relationship

between the two PLQ models but do not support our hypothesis that PLQ_{MS} scores would be lower than PLQ_{WS} scores. The male participants produced more lactate at the same absolute and relative (i.e., %HRR) values during the tests. Previous research exploring the difference in fatigue and recovery rates between males and females found that women fatigued at a slower rate and produced lower levels of lactate (71, 91). They postulated that muscle morphological differences (i.e., women have a higher ratio of Type I fibers) may be a reason. It should also be noted that the male players may have larger leg muscles. Larger muscles capable of producing more lactate could also explain the differences in lactate production. However, as the cross-sectional area of the leg musculature was not measured in this study, this ascertainment cannot be supported by the current data. These research studies support the differences found in the current study. Therefore, the differences in the models can be attributed to differences between the genders and in their fitness levels. Future research is needed to determine if this observed difference is based on a true difference between genders or if this difference is relevant to only this pair of teams.

LIMITATIONS

These models are constructed from small sample sizes (PLQ_{WS} = 22 women, PLQ_{MS} = 18). Therefore, the models produced should not be generalized to NCAA DI female and male soccer players as more data on other teams at this level need to be collected to produce more generalizable models.

Some of the maximal effort testing data for the women was collected in the middle of the season which may have affected the results. As the tests were conducted in the

middle of an off-week where the players had no mid-week games and practices were scheduled to be light, we utilized the data as needed. More research is needed to determine if testing results from before the pre-season and at the middle of the season differ.

All tests were conducted on a treadmill which may have affected the validity of the accelerometer data. Therefore, a physiological running protocol at a known and constant speed is warranted. The Yo-Yo/ Beep/ Bleep test do not satisfy this need as participants are only required to reach the line in the allotted time not to run at a constant speed.

FUTURE DIRECTIONS

The validity of the developed models against $\dot{V}O_2$ data should be determined and compared to previously developed PL models. Data on more teams at the same and other competition levels should be collected to determine if these models are generalizable to other groups. Lastly, designing a protocol that will allow for the ACT data to be utilized should be explored.

CONCLUSION

The purpose of this study was to devise a model for determining the PL of female and male soccer players using newly available measures. The models produced relied on only %HRR not any of the proposed measures and therefore HR monitoring systems capable of retaining the data for the duration of the exercise session are appropriate. While the two models are statistically different, they are very strongly correlated. Also, due to the small sample size the generalizability of the models is limited but in lieu of

other models specifically designed for collegiate level soccer players, these models may be used. More research needs to be conducted to determine if the newly available variables can be incorporated into PLQ models.

REFERENCES

- 2 Aduen J, Bernstein WK, Khastgir T, Miller J, Kerzner R, Bhatiani A, Lustgarten J, Bassin AS, Davison L, Chernow B. The use and clinical importance of a substrate-specific electrode for rapid determination of blood lactate concentrations. *JAMA*. 1994;272(21):1678-85.
- 9 Askanazi J, Milic-Emili J, Broell JR, Hyman AI, Kinney JM. Influence of exercise and CO₂ on breathing pattern in normal man. *J Appl Physiol: Respirat Environ Exer Physiol*. 1979;47(1):192-6.
- 13 Bangsbo J. The physiology of soccer: with special reference to intense intermittent exercise. *Act Physiol Scand*. 1994;151(S619):1-155.
- 14 Banister EW, Calvert TW. Planning for future performance: implications for long term training. *Can J Appl Sport Sci*. 1980;5(3):170-6.
- 15 Banister, EW, Calvert TW, Savage MV, Bach TM. A systems model of training for athletic performance. *Aust J Sp Meds*.1975;7:57-61.
- 17 Banister EW, Good P, Holman G, Hamilton CL. Modeling the Training Response in Athletes. In Landers DM, editor, *Sport and Elite Performers* (Vol. 3, The 1984 Olympic Scientific Congress Proceedings). Champaign: Human Kinetics. 1986. p. 7-23.
- 22 Bishop PA, Smith JF, Kime JC, Mayo JM, Tin YH. Comparison of a manual and an automated enzymatic technique for determining blood lactate concentrations. *Int J Sports Med*. 1992;13(1):36-9.
- 29 Bradley PS, Di Mascio M, Peart D, Olsen P, Sheldon B. High-Intensity Activity Profiles of Elite Soccer Players at Different Performance Levels. *J Strength Cond Res*. 2010;24(9):2343-51.
- 32 Capranica L, Tessitore A, Guidetti L, Figura F. Heart rate and match analysis in pre-pubescent soccer players. *J Sport Sci*. 2001;19(6):379-384.
- 33 Caretti DM, Szlyk PC, Sils IV. Effects of exercise modality on patterns of ventilation and respiratory timing. *Resp Physiol*. 1992;90(2):201-211.
- 43 Edwards S. *The Heart Rate Monitor Book*. Sacramento, CA: Fleet Feet Press, 1990.
- 44 Ekblom B. Applied physiology of soccer. *Sports Med*. 1986;3(1): 50-60.
- 45 Eniseler N. Heart rate and blood lactate concentrations as predictors of physiological load on elite soccer players during various soccer training activities. *J Strength Cond Res*. 2005;19(4):799-804.
- 48 Evans, JD. *Straightforward statistics for the behavioral sciences*. Pacific Grove (CA): Brooks/Cole Publishing, 1996. 634 p.
- 49 Faude O, Kellmann M, Ammann T, Schnitker R, Meyer T. Seasonal changes in stress indicators in high level football. *Int J Sports Med*. 2011;32(4):259-65.
- 59 Gabbett TJ, Mulvey MJ. Time-motion analysis of small-sided training games and competition in elite women soccer players. *J Strength Cond Res*. 2008;22(2):543-52.
- 63 González-Haro C, San Millan I, González-de-Suso JM, Galilea P. TRIMP methodological issues. A new accurate methodology. *Med Sci Sports Exerc*. 2009;41(5), 151.

- 68 Helgerud J, Engen LC, Wisloff U, Hoff J. Aerobic endurance training improves soccer performance. *Med Sci Sports Exerc.* 2001;33(11):1925-1931.
- 71 Hicks AL, Kent-Braun J, Ditor DS. Sex Differences in Human Skeletal Muscle Fatigue. *Exer Sport Sci Rev.* 2001;29(3):109-112.
- 72 Hoff J, Wisløff U, Engen LC, Kemi OJ, Helgerud J. Soccer specific aerobic endurance training. *Br J Sports Med.* 2002;36(3):218-221.
- 73 Hoffman J. *Norms for Fitness, Performance and Health.* Champaign: Human Kinetics; 2006. 223 p.
- 75 Inbar O, Oten A, Scheinowitz M, Rotstein A, Dlin R, Casaburi R. Normal cardiopulmonary responses during incremental exercise in 20-70-yr-old men. *Med Sci Sport Exerc.* 1994;26(5):538-46.
- 77 Jacobs I, Westlin N, Karlsson J, Rasmusson M, Houghton B. Muscle glycogen and diet in elite soccer players. *Eur J Appl Physiol Occup Physiol.* 1982;48(3):297-302.
- 80 Kalapotharakos VI, Ziogas G, Tokmakidis SP. Seasonal aerobic performance variations in elite soccer players. *J Strength Cond Res.* 2011;25(6):1502-7.
- 81 Karvonen J, Chwalbinska-Monet J, Säynäjäkangas S. Comparison of heart rates measured by ECG and microcomputer. *Physician and Sport Med,* 1984;12(6): 65-69.
- 82 Karvonen J, Vuorimaa T. Heart rate and exercise intensity during sports activities. Practical application. *Sports Med.* 1988;5(5):303-11.
- 86 Köklü Y, Aşçi A, Koçak FU, Alemdaroğlu U, Dündar U. Comparison of the Physiological Responses to Different Small-Sided Games in Elite Young Soccer Players. *J Strength Cond Res.* 2011;25(6):1522-1528.
- 87 Krustup P, Mohr M, Steensberg A, Bencke J, Kjaer M, Bangsbo J. Muscle and blood metabolites during a soccer game: implications for sprint performance. *Med Sci Sports Exerc.* 2006;38(6): 1165-1174.
- 91 Laurent CM, Green JM, Bishop PA, Sjökvist J, Schumacker RE, Richardson MT, Curtner-Smith M. Effect of gender on fatigue and recovery following maximal intensity repeated sprint performance. *J Sports Med Phys Fitness.* 2010;50(3):243-53.
- 96 Lucia A, Hoyos J, Santalla A, Earnest C, Chicharro JL. Tour de France versus Vuelta a España: Which is harder? *Med Sci Sports Exerc.* 2003;35(5):872-8.
- 98 Manzi V, Castagna C, Padua E, Lombardo M, D'Ottavio S, Massaro M, Volterrani M, Iellamo F. Dose-response relationship of autonomic nervous system responses to individualized training impulse in marathon runners. *Am J Physiol Heart Circ Physiol.* 2009;296(6):733-40.
- 99 Manzi V, Iellamo F, Impellizzeri F, D'Ottavio S, Castagna C. Relation between individualized training impulses and performance in distance runners. *Med Sci Sports Exerc.* 2009;41(11):2090-6.
- 103 McLean SR, Norris SR, Smith DJ. Comparison of the Lactate Pro and the YSI 1500 Sport Blood Lactate Analyzers. *Int J Appl Sp Sci.* 2004;16(2):22-30.
- 106 Miller TA, Thierry-Aguilera R, Congleton JJ, Amendola AA, Clark MJ, Crouse SF, Martin SM, Jenkins OC. Seasonal changes in VO₂max among Division 1A collegiate women soccer players. *J Strength Cond Res.* 2007;21(1):48-51.

- 107 Millet GP, Candau RB, Barbier B, Busso T, Rouillon JD, Chatard JC. Modelling the transfers of training effects on performance in elite triathletes. *Int J Sports Med.* 2002;23:55–63.
- 108 Millet GP, Gros Lambert A, Barbier B, Rouillon JD, Candau RB. Modelling the relationships between training, anxiety, and fatigue in elite athletes. *Int J Sports Med.* 2005;26:492–8.
- 109 Mohr M, Krstrup P, Andersson H, Kirkendal D, Bangsbo J. Match activities of elite women soccer players at different performance levels. *J Strength Cond Res.* 2008;22(2):341-349.
- 122 Pyne DB, Boston T, Martin DT, Logan A. Evaluation of the Lactate Pro blood lactate analyzer. *Eur J Appl Physiol.* 2000;82:112-6.
- 127 Robergs RA & R Landwehr. The surprising history of the “HRmax = 220 - Age” equation. *JEPonline.* 2002;5(2). Downloaded April 7, 2011 from <http://faculty.css.edu/tboone2/asep/Robergs2.pdf> and <http://faculty.css.edu/tboone2/asep/Robergs.doc>.
- 130 Scheuermann BW, Kowalchuk JM. Breathing Patterns during Slow and Fast Ramp Exercise in Man. *Experi Physiol.* 1999;84:109-120.
- 131 Seaward BL, Sleamaker RH, McAuliffe T, Clapp JF 3rd. The precision and accuracy of a portable heart rate monitor. *Biomed Instrum Technol.* 1990;24(1):37-41.
- 137 Stagno KM, Thatcher R, van Someren KA. A modified TRIMP to quantify the in-season training load of team sport players. *J Sports Sci.* 2007;25(6):629-634.
- 139 Stølen T, Chamari K, Castagna C, Wisløff U. Physiology of soccer: an update. *Sports Med,* 2005;35(6):501-36.
- 140 Strøyer J, Hansen L, Klausen K. Physiological profile and activity pattern of young soccer players during match play. *Med Sci Sports Exerc.* 2004; 36(1): 168-74.
- 145 Tanner RK, Fuller KL, Ross MLR. Evaluation of three portable blood lactate analyzers: Lactate Pro, Lactate Scout and Lactate Plus. *Eur J Appl Physiol.* 2010;109:551-9.
- 149 Wajciechowski JA, Gayle RC, Andrews RL, Dintiman GB. The accuracy of radio telemetry heart rate monitoring during exercise. *Clinical Kinesiology.* 1991;45:9-12.
- 152 Weil MH, Leavy JA, Rackow EC, Halfman CJ, Bruno SJ. Validation of a semi-automated technique for measuring lactate in whole blood. *Clinical Chemistry.* 1986;32:2175-7.
- 154 Wilson II RW, Reynolds K, Snyder AC. Use of a Physiological Monitoring System to Determine Ventilatory Threshold. *J Strength Cond Res* 2011;25(S1): S113.
- 157 Wood RE, Hayter S, Rowbottom D, Stewart I. Applying a mathematical model to training adaptation in a distance runner. *Eur J Appl Physiol.* 2005;94(3):310-6.

ACKNOWLEDGMENTS

This study was partially funded by Zephyr Technologies, Inc.

Study 2: Validation of Models for the Determination of the Physiological Load of Collegiate Soccer Players

Robert W. Wilson, II, and Ann C. Snyder

Human Performance Laboratory, Department of Kinesiology, College of Health
Sciences, University of Wisconsin – Milwaukee

Keywords: TRIMPs, training load, heart rate, Bland-Altman plots

Abstract

Mathematical models generated from laboratory tests may have face-validity. This may satisfy the standards of practitioners. However, for a methodology to be used for scientific studies the validity of the model needs to be assessed against “gold standard” variables. **PURPOSE:** To assess the validity of two models for the determination of the quantity of physiological load (PL) of female and male soccer players. **METHODS:** Well-trained competitive NCAA DI soccer players (female=11, male=15) completed sub-maximal and maximal effort laboratory treadmill tests. The quantity of PL (PLQ) was calculated for each participant for each stage from the sub-maximal tests. Pearson’s correlations (r) for individuals and coefficients of determination (CoD) for grouped data between the PL scores were calculated for both models and four measures of oxygen uptake [$\dot{V}O_2$]; absolute ($\dot{V}O_{2abs}$), relative per kg body weight ($\dot{V}O_{2-rel}$), and percentages of maximal ($\% \dot{V}O_{2max}$) and reserve ($\% \dot{V}O_{2R}$) values]. Bland-Altman plots were also created to assess the level of agreement between measured and predicted $\dot{V}O_2$ values. **RESULTS:** Very strong relationships were found between the individual PLQ scores and the $\dot{V}O_2$ values (range: females $r = 0.8230 - 0.9953$, males $r = 0.9771 - 0.9993$). All of the CoD values were lower for the female than for the male players (female v male: $\dot{V}O_{2-abs}$: 0.49 v 0.75, $\dot{V}O_{2-rel}$: 0.51 v 0.79, $\% \dot{V}O_{2max}$: 0.26 v 0.85, $\% \dot{V}O_{2R}$: 0.40 v 0.85). Bland-Altman plots depicted a high-level of agreement between the measured and predicted $\dot{V}O_2$ variables, indicating a good level of agreement between the $\dot{V}O_2$ values predicted from the regression equations for the grouped data and the observed data. **CONCLUSION:** Both PLQ models have been shown to be valid measures of the PL of college-aged soccer players.

Keywords: TRIMPs, training load, heart rate, training, Bland-Altman plots

INTRODUCTION

Coaches plan successive training sessions with the desire of increasing an athlete's physical and sporting abilities. The ultimate goal is to attain peak performance at a predetermined point in the season, usually the end of the season and/or during the championship/playoff period. Many mathematical models have been developed to assess the physiological load (PL) of athletes during practices and competitions using physiological (14, 17, 43, 63, 96, 98, 107, 137, 157) or psychometric (54) variables. These models have been used to assess the PL of runners (98, 99, 157), cyclists (41, 55, 96, 120, 128, 144), swimmers (69, 116, 147), well-trained athletes (51, 52, 54) and soccer (3, 4, 74, 78), basketball (100), field hockey (137) and rugby (58) players.

While these models have been used extensively in the field and have been presented in research, there has been little research that indicates that these methods are valid. Models which utilize physiological variables to determine their respective scores have face validity or ecological validity (150), however, they have not been validated against a "gold standard" measure of workload, such as oxygen uptake ($\dot{V}O_2$). Validation of these models has been lacking, as only the session RPE model (sRPE) has been correlated with the percentages of maximal $\dot{V}O_2$ ($\% \dot{V}O_{2max}$), peak heart rate ($\%HR_{peak}$), and heart rate reserve ($\%HRR$) (70). The sRPE model has been shown to be very strongly related to $\dot{V}O_{2peak}$ ($r \sim 0.87$). However, the level of agreement between these sets of variables was not assessed in these studies (70, 150).

The level of agreement between the measured and the predicted variables as determined by the Bland-Altman (5, 24) methods has not been conducted in this line of

research. Bland-Altman plots graphically portrays the difference between two measures of the same variable against the average of the two measures.

The purpose of this study was to assess the internal validity of two recently developed models for determining PL (153) by assessing the degree of relationship between the quantity of PL (PLQ) from the models and multiple $\dot{V}O_2$ values (i.e., absolute oxygen uptake ($\dot{V}O_{2-abs}$), relative oxygen uptake ($\dot{V}O_{2-rel}$), $\% \dot{V}O_{2max}$, and percent of reserve oxygen uptake ($\% \dot{V}O_{2R}$)) on individual and group levels, and assessing the level of agreement between the measured and predicted $\dot{V}O_2$ variables using the Bland-Altman plot technique. We hypothesized that there would be a strong to very strong level of relationship and a high level of agreement between the measured and predicted objective measures of physical work thus showing that the models were valid determinants of PL.

METHODS

Subjects. Eleven (n=11) female and fifteen (n=15) male collegiate well-trained competitive National Collegiate Athletics Association (NCAA) Division I (DI) soccer players ($\bar{x} \pm s$: ages 19.0 ± 0.9 and 19.7 ± 1.6 yr, weight 60.9 ± 6.8 and 76.4 ± 11.2 kg, height 1.66 ± 0.06 and 1.80 ± 0.07 m, BMI 22.1 ± 1.9 and 23.4 ± 2.1 kg \cdot m⁻², respectively) participated in this study. All participants were informed of the aims and objectives of the study before completing informed consent and health history documents. This study was approved by the Institutional Review Board of the University of Wisconsin – Milwaukee.

Procedures. All participants completed sub-maximal and maximal effort treadmill tests in the laboratory. Heart rate (HR) and $\dot{V}O_2$ were measured continuously using

monitors from the Polar Team1 monitoring system (Polar Electro, Oy, Kempele, Finland) and the MetaMax 3B portable gas analysis system (Cortex Biphysik, GmbH, Leipzig, Germany). The female participants completed a sub-maximal effort treadmill (SM) protocol with a variable start. The initial stage was set at a speed to elicit a HR of approximately $140 \text{ beats} \cdot \text{min}^{-1}$ (Table 3.2.1). The incline was set at 1% (79) and speed was increased by $0.8 \text{ km} \cdot \text{h}^{-1}$ per stage. In contrast, male participants completed a standardized sub-maximal effort treadmill protocol (Table 3.2.1). The incline was set at 1%, initial speed was $6.0 \text{ km} \cdot \text{h}^{-1}$ and was increased by $2.0 \text{ km} \cdot \text{h}^{-1}$ per stage. The duration of the stages in both SM protocols was 6 min. Blood was collected for blood lactate concentration ([HLA]) analysis during the min 6 of each SM stage. The maximal effort treadmill (HMC) protocols started with 0% incline, and increased in speed by $1 \text{ km} \cdot \text{h}^{-1}$ and incline by 2%, alternately, after the first stage (Table 3.2.2). Blood for [HLA] analysis was collected 1 min after the conclusion of the HMC test. All stages were 1 min in duration. Women started at a speed of $6 \text{ km} \cdot \text{h}^{-1}$ and men started at $7 \text{ km} \cdot \text{h}^{-1}$. Female participants completed the SM test prior to their Fall pre-season training and HMC tests were conducted during an off-/ rest week in the middle of the season. Male participants completed SM and HMC protocols prior to their Fall pre-season training on the same day separated by a recovery period.

Table 3.2.1. Sub-maximal Effort Treadmill Protocols (Variable and Standardized start).

Start	End	Incline (%)	Variable start Speed (km • h ⁻¹)	Standardized start Speed (km • h ⁻¹)
0:00	6:00	1	Starting HR ~140 bpm	6.0
6:00	12:00	1	+0.80/ stage	8.0
12:00	18:00	1	“	10.0
18:00	24:00	1	“	12.0
24:00	30:00	1	“	14.0
30:00	36:00	1	“	16.0
36:00	42:00	1	“	18.0
42:00	48:00	1	“	20.0
48:00	54:00	1	“	22.0

Table 3.2.2. Human Performance Laboratory Modified Conconi Maximal Effort Treadmill Protocols (HMC10 and HMC11).

Start	End	Incline (%)	HMC10	HMC11
			Speed (km • h ⁻¹)	Speed (km • h ⁻¹)
0:00	1:00	0	6.0	7.0
1:00	2:00	0	7.0	8.0
2:00	3:00	2	7.0	8.0
3:00	4:00	2	8.0	9.0
4:00	5:00	4	8.0	9.0
5:00	6:00	4	9.0	10.0
6:00	7:00	6	9.0	10.0
7:00	8:00	6	10.0	11.0
8:00	9:00	8	10.0	11.0
9:00	10:00	8	11.0	12.0
10:00	11:00	10	11.0	12.0
11:00	12:00	10	12.0	13.0
12:00	13:00	12	12.0	13.0
13:00	14:00	12	13.0	14.0

Obtained data. Sub-maximal $\dot{V}O_2$ data for eight female (n=8) and fifteen male (n=15) participants were collected from the SM tests. For each stage of the SM test, the HR and $\dot{V}O_2$ values from the plateau of each stage were used for the comparative analyses. A plateau was defined as the 1 min period in the last 2.5 min of each stage

which produced the lowest standard deviation. The mean $\dot{V}O_2$ for the plateau period was used as the representative $\dot{V}O_2$ for that stage.

PLQ scores were determined by entering all of the %HRR values for each 1-min plateau period into the appropriate PLQ model (153) (female data: PLQ_{WS} (Equation 3.2.1), male data: PLQ_{MS} (Equation 3.2.2)), and then summing them to produce the PLQ scores. The score was multiplied by 6 to produce the PLQ score for that SM stage.

$$PLQ_{WS} = \sum [(0.90886 + 0.00705673 \cdot e^{(7.03434 \cdot \%HRR_i)}) \cdot sr^{-1}] \quad 3.2.1$$

$$PLQ_{MS} = \sum [(0.235182 \cdot e^{(3.55248 \cdot \%HRR_i)}) \cdot sr^{-1}] \quad 3.2.2$$

Maximal $\dot{V}O_2$ values for three female (n=3) and fifteen male (n=15) individuals were determined from the maximal effort tests and used to determine the percentages of maximal oxygen uptake (% $\dot{V}O_{2max}$) and oxygen uptake reserve (% $\dot{V}O_{2R}$). Similarly, maximal HR values for each individual were determined from the maximal effort tests and used to determine the %HRR. The criterion for the maximal effort test was met, if there was no change in $\dot{V}O_2$ with an increase in workload. If this plateau was not present, then 2 of these 3 criteria needed to be met: a respiration exchange ratio of >1.10, a blood lactate concentration of >8.0 ml of lactate $\cdot L^{-1}$ of blood after the last stage, an RPE of >9.0 on the Modified-Borg 10 point scale. If the HR_{max} was not obtainable from the laboratory tests, the highest HR from the first week of pre-season training (including a scrimmage and field-testing) was used.

Bland-Altman plots were constructed by plotting pairs of the average of the two values of interest on the x-axis against the difference between those two values on the y-axis. The mean of the difference for the pairs was termed as “the bias”. Horizontal lines at ± 1 and ± 2 standard deviations were plotted as visual indices of the level of agreement.

Differences in the relationship between HR and $\dot{V}O_2$ have been expressed depending on how these variables are reported (93, 142). Therefore, as the PLQ models use %HRR, we assessed the validity of the models against multiple expressions of $\dot{V}O_2$ (i.e., $\dot{V}O_{2-abs}$, $\dot{V}O_{2-rel}$, % $\dot{V}O_{2max}$, and % $\dot{V}O_{2R}$).

Statistical analysis. The relationship between the respective PLQ scores and the relevant $\dot{V}O_2$ values were analyzed using Pearson's correlations (r) between PLQ scores and $\dot{V}O_2$ values for each stage for each individual and the coefficients of determination (R^2) for data grouped by gender using IBM SPSS Statistics (v19, IBM Corp, New York). The $\dot{V}O_2$ measured were compared to the predicted $\dot{V}O_2$ values generated from the regression equation of the group data to determine the level of agreement using Bland Altman plots. The Bland-Altman plots were generated using Microsoft Excel 2007 (Microsoft Corporation, Redmond WA).

RESULTS

Very strong correlations exist between the stage PLQ scores and the $\dot{V}O_2$ values of interest for each individual as indicated by the Pearson product moment correlation coefficients (r) (range: females: 0.8446 - 0.9969, males: 0.9771 – 0.9993, Tables 3.2.3 and 3.2.4). The R^2 values were higher for the male than for the female players (female v male: $\dot{V}O_{2-abs}$: 0.4860 v 0.7505, $\dot{V}O_{2-rel}$: 0.5102 v 0.7907, % $\dot{V}O_{2max}$: 0.2598 v 0.8453, % $\dot{V}O_{2R}$: 0.3993 v 0.8479, Figure 3.2.1a – 3.2.1d).

Table 3.2.3. Pearson product-moment correlation coefficients (r) between the PL score for individual female soccer players (PLQ_{WS}) and measures of oxygen uptake (absolute oxygen uptake ($\dot{V}O_{2-abs}$); relative oxygen uptake ($\dot{V}O_{2-rel}$), percent of maximal oxygen uptake ($\% \dot{V}O_{2max}$) and percent of oxygen uptake reserve ($\% \dot{V}O_{2R}$)).

Participant	$\dot{V}O_{2-abs}$	$\dot{V}O_{2-rel}$	$\% \dot{V}O_{2max}$	$\% \dot{V}O_{2R}$
A1	0.99	0.99	0.99	0.99
B1	0.99	0.99	NA	NA
C1	0.98	0.98	NA	NA
D1	0.99	0.99	NA	NA
E1	0.99	0.99	NA	NA
F1	0.89	0.88	NA	NA
G1	0.84	0.85	NA	NA
H1	0.99	1.00	NA	NA
I1	0.97	0.97	0.97	0.97
J1	0.97	0.97	0.97	0.97
K1	0.98	0.98	NA	NA
$\bar{x} \pm s$	0.96 ± 0.05	0.96 ± 0.05	0.98 ± 0.01	0.98 ± 0.01

Table 3.2.4. Pearson product-moment correlation coefficients (r) between the PL score for individual male soccer players (PLQ_{MS}) and measures of oxygen uptake (absolute oxygen uptake ($\dot{V}O_{2-abs}$); relative oxygen uptake ($\dot{V}O_{2-rel}$), percent of maximal oxygen uptake ($\% \dot{V}O_{2max}$) and percent of oxygen uptake reserve ($\% \dot{V}O_{2R}$)).

Participant	$\dot{V}O_{2-abs}$	$\dot{V}O_{2-rel}$	$\% \dot{V}O_{2max}$	$\% \dot{V}O_{2R}$
A2	0.99	0.99	0.99	0.99
B2	0.98	0.98	0.98	0.98
C2	0.98	0.98	0.98	0.98
D2	0.99	0.99	0.99	0.99
E2	0.98	0.98	0.98	0.98
F2	0.99	0.99	0.99	0.99
G2	0.99	0.99	0.99	0.99
H2	1.00	1.00	1.00	1.00
I2	1.00	1.00	1.00	1.00
J2	0.99	0.99	0.99	0.99
K2	1.00	1.00	1.00	1.00
L2	1.00	1.00	1.00	1.00
M2	0.99	0.99	0.99	0.99
N2	1.00	1.00	1.00	1.00
O2	1.00	1.00	1.00	1.00
$\bar{x} \pm s$	0.99 ± 0.01	0.99 ± 0.01	0.99 ± 0.01	0.99 ± 0.01

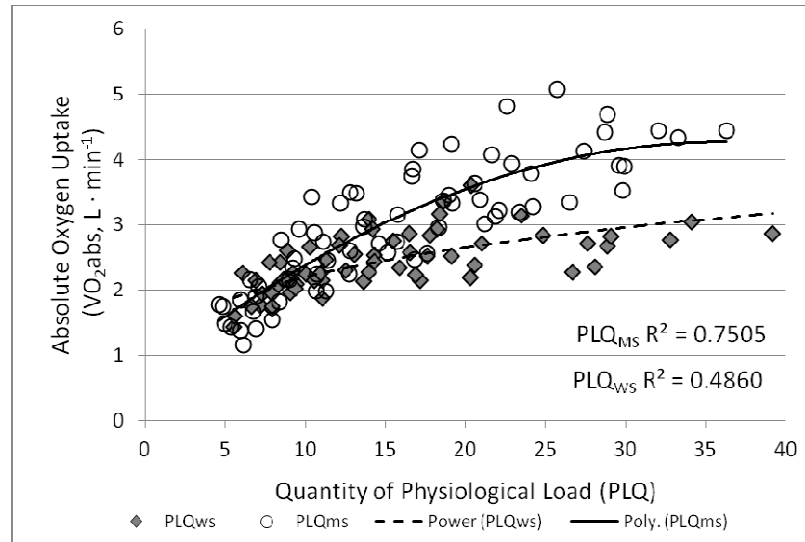

Figure 3.2.1a. Scatterplots of quantity of physiological load (PLQ) against absolute oxygen uptake ($\dot{V}O_{2-abs}$) for female (shaded diamonds) and male (open circles) participants. Best-fit regression lines were plotted for the pooled data for female (dashed line) and male (solid line) participants with the type of formula listed in each figure.

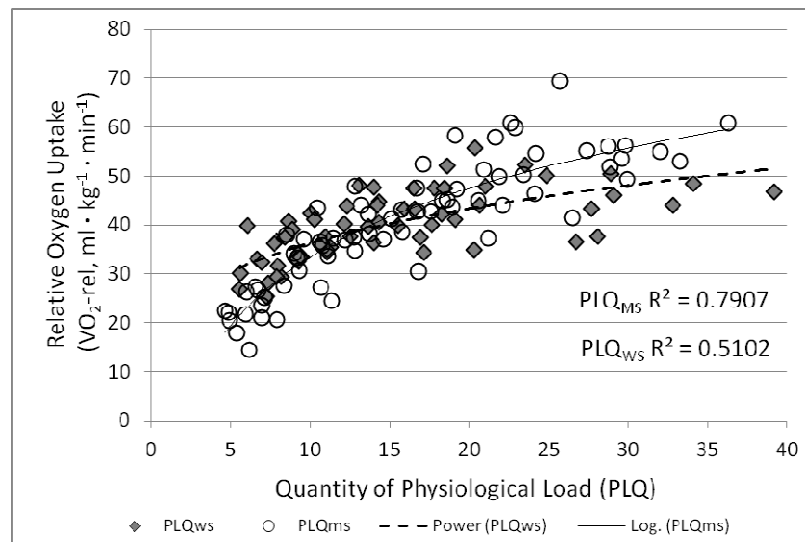

Figure 3.2.1b. Scatterplots of quantity of physiological load (PLQ) against relative oxygen uptake ($\dot{V}O_{2-rel}$), for female (shaded diamonds) and male (open circles) participants. Best-fit regression lines were plotted for the pooled data for female (dashed line) and male (solid line) participants with the type of formula listed in each figure.

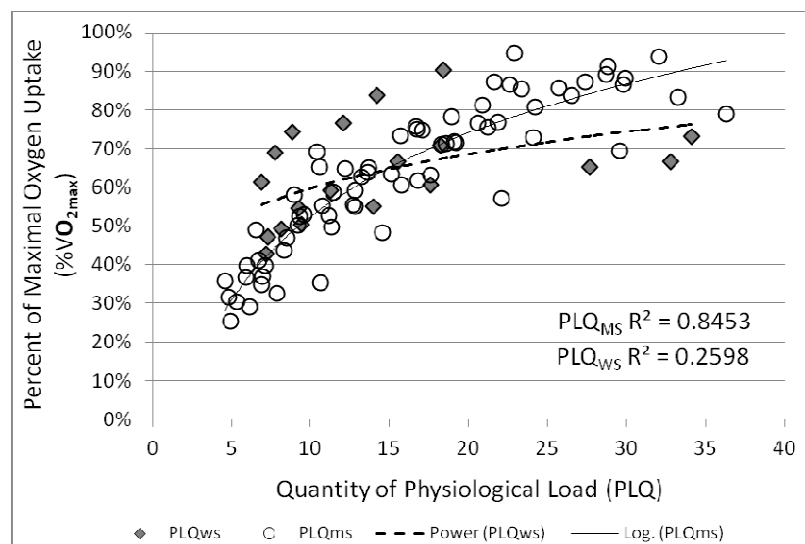

Figure 3.2.1c. Scatterplots of quantity of physiological load (PLQ) against percent of maximal oxygen uptake ($\% \dot{V}O_{2max}$) for female (shaded diamonds) and male (open circles) participants. Best-fit regression lines were plotted for the pooled data for female (dashed line) and male (solid line) participants with the type of formula listed in each figure.

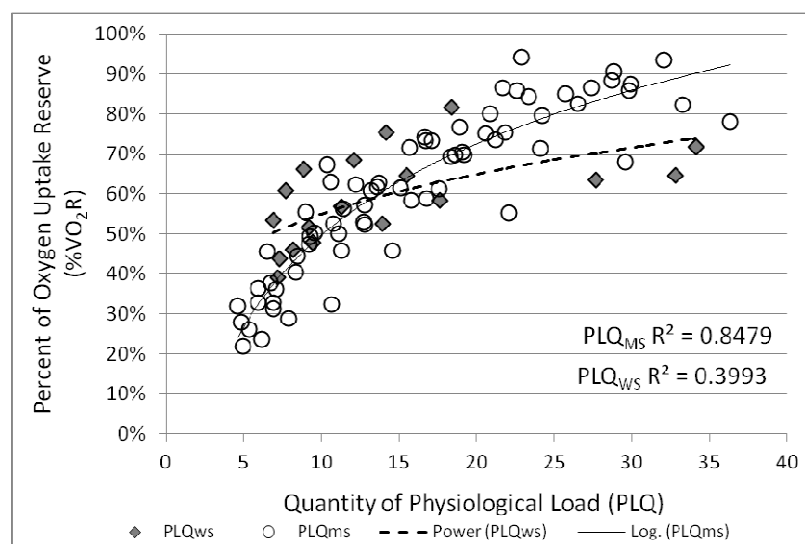

Figure 3.2.1d. Scatterplots of quantity of physiological load (PLQ) against percent of oxygen uptake reserve ($\% \dot{V}O_{2R}$) for female (shaded diamonds) and male (open circles) participants. Best-fit regression lines were plotted for the pooled data for female (dashed line) and male (solid line) participants with the type of formula listed in each figure.

Bland-Altman plots depicted a high-level of agreement between the measured and predicted $\dot{V}O_2$ variables. (Figures 3.2.2a – 3.2.2b and 3.2.3a – 3.2.3d). The women's data

does show a tendency to underestimate $\dot{V}O_2$ values at lower intensities and overestimate $\dot{V}O_2$ at higher intensities. (Figures 3.2.2a – 3.2.2b)

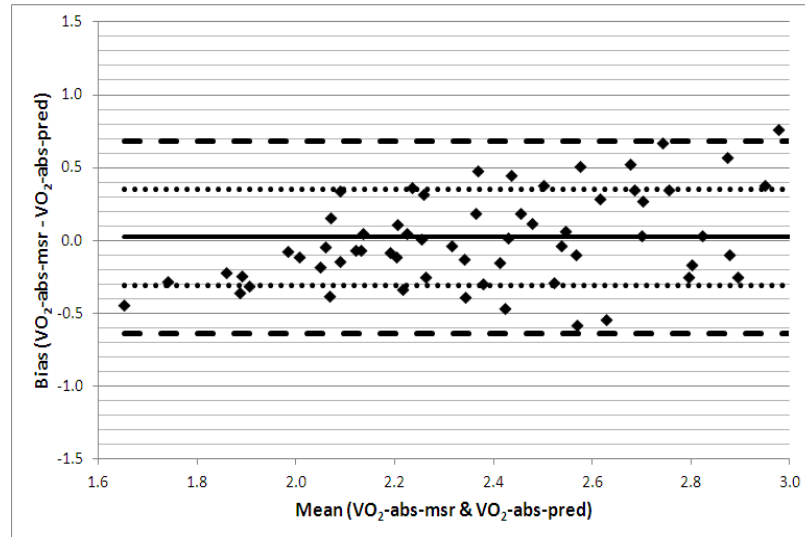

Figure 3.2.2a. Bland-Altman Plot measured absolute oxygen uptake ($\dot{V}O_2$ -abs-msr) and predicted absolute oxygen uptake ($\dot{V}O_2$ -abs-pred) from the group $\dot{V}O_2$ -abs curves for female participants. (Solid bold line = mean of bias; dotted bold line = ± 1 standard deviation, dashed bold line = ± 2 standard deviations)

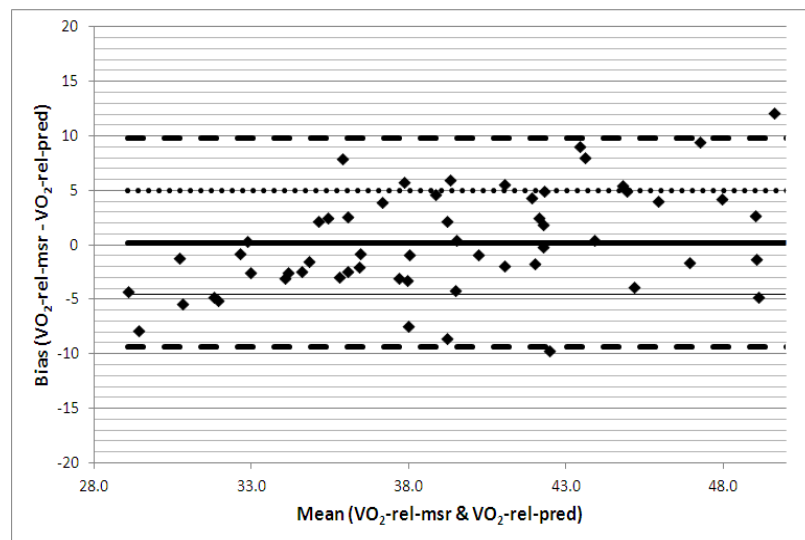

Figure 3.2.2b. Bland-Altman Plot measured relative oxygen uptake ($\dot{V}O_2$ -rel-msr) and predicted relative oxygen uptake ($\dot{V}O_2$ -rel-pred) from the group $\dot{V}O_2$ -rel curve for female participants. (Solid bold line = mean of bias; dotted bold line = ± 1 standard deviation, dashed bold line = ± 2 standard deviations)

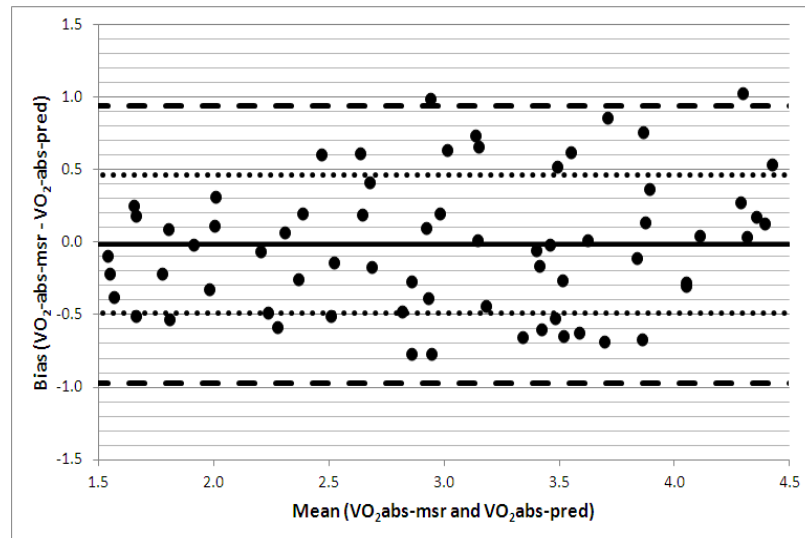

Figure 3.2.3a Bland-Altman Plot measured absolute oxygen uptake ($\dot{V}O_{2\text{-abs-msr}}$) and predicted absolute oxygen uptake ($\dot{V}O_{2\text{-abs-pred}}$) from the group $\dot{V}O_{2\text{-abs}}$ curve for male participants. (Solid bold line = mean of bias; dotted bold line = ± 1 standard deviation, dashed bold line = ± 2 standard deviations)

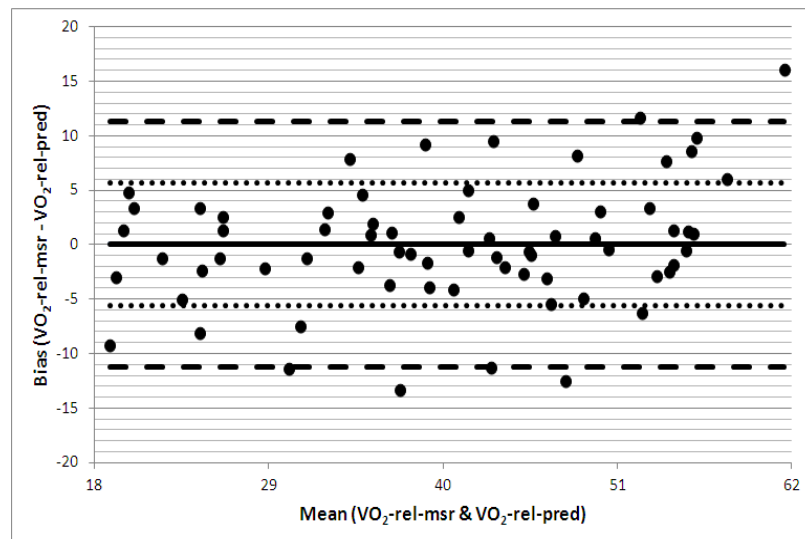

Figure 3.2.3b. Bland-Altman Plot measured relative oxygen uptake ($\dot{V}O_{2\text{-rel-msr}}$) and predicted relative oxygen uptake ($\dot{V}O_{2\text{-rel-pred}}$) from the group $\dot{V}O_{2\text{-rel}}$ curve for male participants. (Solid bold line = mean of bias; dotted bold line = ± 1 standard deviation, dashed bold line = ± 2 standard deviations)

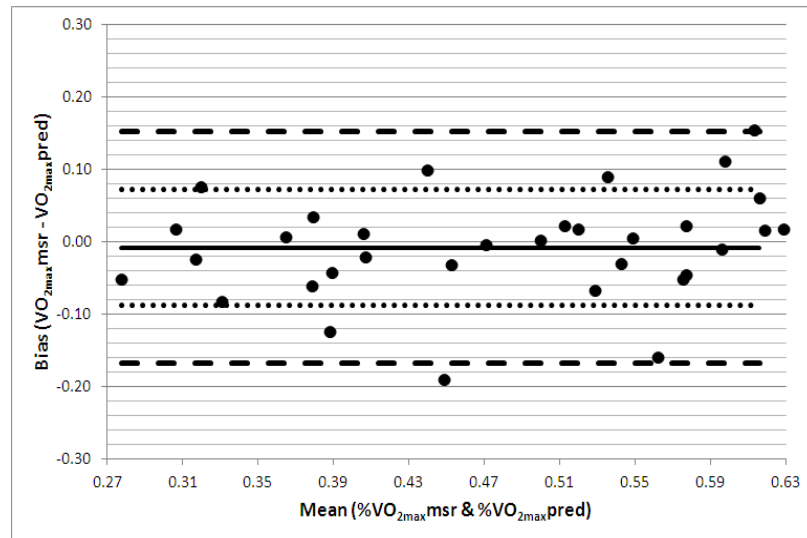

Figure 3.2.3c Bland-Altman Plot measured percent of maximal oxygen uptake ($\% \dot{V}O_{2\max}\text{-msr}$) and predicted percent of maximal oxygen uptake ($\% \dot{V}O_{2\max}\text{-pred}$) from the group $\% \dot{V}O_{2\max}$ curve for male participants. (Solid bold line = mean of bias; dotted bold line = ± 1 standard deviation, dashed bold line = ± 2 standard deviations)

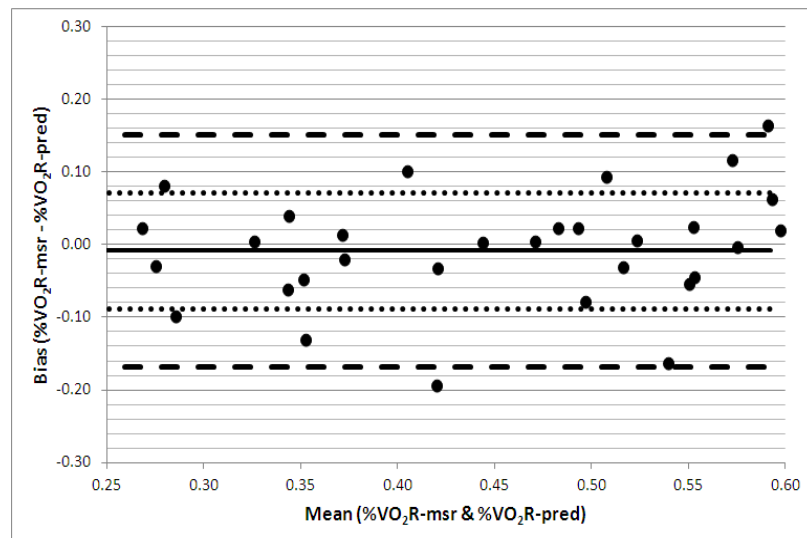

Figure 3.2.3d. Bland-Altman Plot measured percent of oxygen uptake reserve ($\% \dot{V}O_{2R}\text{-msr}$) and predicted percent of reserve oxygen uptake reserve ($\% \dot{V}O_{2R}\text{-pred}$) from the group $\% \dot{V}O_{2R}$ curve for male participants. (Solid bold line = mean of bias; dotted bold line = ± 1 standard deviation, dashed bold line = ± 2 standard deviations)

DISCUSSION

When determining the strain (physiological load) of athletes it is important to use models which are valid and reliable. The objectives of this study were to assess the validity of the mathematical models for the determination of the PL of female and male soccer players. The PLQ scores were calculated by entering the %HRR values for players in their respective team-specific models (Equations 3.2.1 and 3.2.2) from the plateaus in the SM tests. Very strong correlations were obtained at the level of the individual and a high predictive ability for the men and women at the team level. Scores for both female and male soccer players had a level of agreement between measured and predicted oxygen uptake scores. However, the data for the male players showed no under- or over- representation like the female players' data did.

In this study the two groups of athletes were tested using different sub-maximal effort protocols which could explain some of the team level differences. The protocol used to test the women utilized a variable starting speed and a slower rate of increase in speed. Based on the warm-up, the female participants started their tests at a speed that would elicit a heart rate response of approximately $140 \text{ beats} \cdot \text{min}^{-1}$ (approximately 60% HRR). Previous unpublished testing data from our lab indicates that starting athletes of this caliber and age at $\sim 140 \text{ beats} \cdot \text{min}^{-1}$ would allow for 2–3 stages before lactate threshold, and thus a test that would last between 18 and 30 min. The resulting PLQ scores for these participants at the lower stages tend to differ less and a clustering of values appears at the lower PLQ scores and $\dot{V}O_2$ values (see Figure 3.2.1c). This clustering may be due to the greater number of stages completed at a walking intensity. A cluster of data for the male participants is minimal and exists only at the lowest levels of PLQ and $\dot{V}O_2$ values.

Due to scheduling and technical issues, data from only three female participants were able to be used in the $\% \dot{V}O_{2\max}$ and $\% \dot{V}O_{2R}$ analysis. Therefore, the data graphed (Figures 3.2.1c and 3.2.1d) represented only the available data. These data were presented only for demonstrative purposes. The individual correlations presented in Table 3.2.3 are the same regardless of the $\dot{V}O_2$ measure. Additional data needs to be obtained to assess whether the trend in the men's data exists in the women's data.

The correlations between the $\dot{V}O_2$ values and the PLQ scores for both female and male soccer players on an individual level were all very strong (Tables 3.2.3 and 3.2.4). The PLQ scores were generated by entering percent of heart rate reserve ($\%HRR$) values into the model. Therefore, it was expected that there would be a stronger relationship between the PLQ scores and $\% \dot{V}O_{2R}$ due to the relationship between $\% \dot{V}O_2 R$ and $\%HRR$ (93, 142). While slight differences between genders were found for the correlations based on each individual's tests, there were no variations within each gender (Tables 3.2.3 and 3.2.4).

The CoDs of the grouped data show more variation between the groups and within the group of women soccer players (Figures 3.2.1a – 3.2.1d). We propose that these variations are based on the differences between the testing protocols and differences in general fitness levels between the groups. The smaller increase in stress to the female players from stage to stage led to a clustering of the PLQ scores and a slower rate of increase in the observed $\dot{V}O_2$ values. Noticeably different slopes of the individual's curve are seen between the women's and the men's data (Figure 3.2.4a – 3.2.4b). PLQ: $\dot{V}O_2$ -abs curves with lower slopes may indicate participants who engaged in more stages before LT (Figure 3.2.4a – 3.2.4b). Those participants with a higher slope engaged in

fewer stages and consumed more oxygen than those individuals with lower slopes and reached a higher $\dot{V}O_{2\max}$ (Figures 3.2.1c, 3.2.4a and 3.2.4b). More men exceeded greater than 80% of the $\dot{V}O_{2\max}$ than did women during the sub-maximal effort tests (Figure 3.2.1c). Future studies are needed to determine if these differences are based on the differences in the protocol or the fitness level of the athletes.

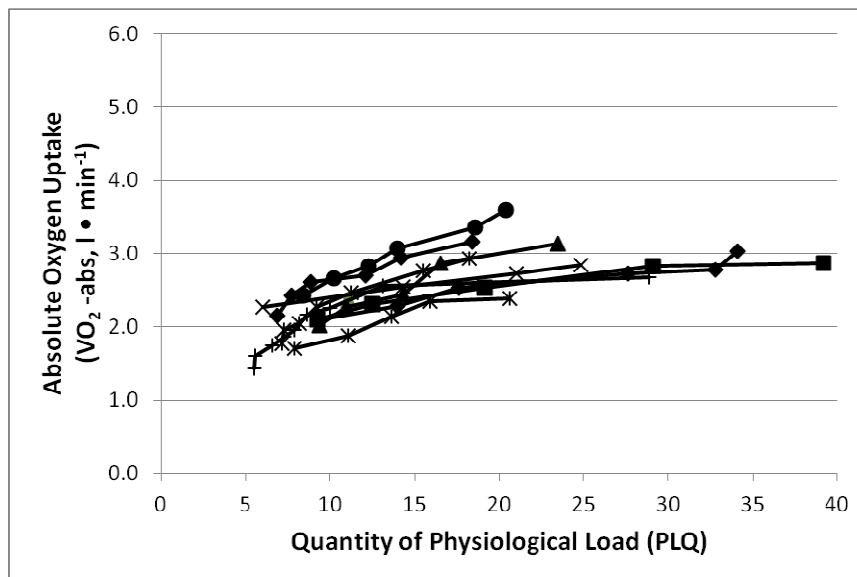

Figure 3.2.4a. Quantity of physiological load (PLQ) for individual players against absolute oxygen uptake ($\dot{V}O_{2\text{-abs}}$) curves from each female participant's sub-maximal effort tests.

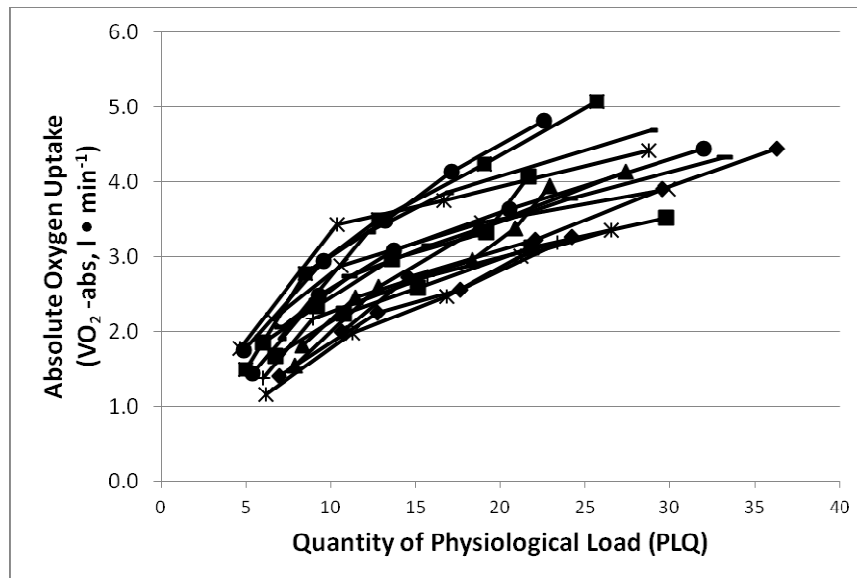

Figure 3.2.4b. Quantity of physiological load (PLQ) for individual players against absolute oxygen uptake ($\dot{V}O_{2-abs}$) curves from each male participant's sub-maximal effort tests.

The only previous study to explore the relationship between a method of determining the PL model and “gold standard” value indicated a strong correlation between sRPE, a psycho-physiological model, and $\dot{V}O_{2peak}$ ($R^2=0.76$) using polynomial equations (70). The data from the female athletes were not as strongly correlated as the male athlete's (Figure 3.2.1c). Therefore, it is necessary to determine if using a standardized protocol would improve the women's CoD.

Bland-Altman plots were produced to assess the level of agreement between the measured and predicted $\dot{V}O_2$ variables measured (Figures 3.2.2a – 3.2.2b and 3.2.3a – 3.2.3d). Bland-Altman plots indicating a high level of agreement will have bias lines close to zero and data that are evenly dispersed within ± 2 standard deviations of the bias line (24). Both models appeared to have a good level of agreement. However, the data indicated a tendency for the women's model to under-estimate $\dot{V}O_{2-abs}$ and $\dot{V}O_{2-rel}$

at lower intensities and to over-estimate these variables at higher intensities. The Bland-Altman plots for the men show more agreement as there are no biases.

CONCLUSION

Models for the determination of PL for a female and a male NCAA DI soccer team have been recently produced from their SM and HMC test values (153). While these models are intuitive, validation of the scores produced by these models against the “gold standard” variable of $\dot{V}O_2$ expressed as absolute ($l \cdot \text{min}^{-1}$) and relative ($\text{ml} \cdot \text{kg}^{-1} \cdot \text{min}^{-1}$) values, and as $\% \dot{V}O_{2\text{max}}$ and $\% \dot{V}O_{2R}$ values. The high levels of agreement indicated, by the very strong relationship between the PLQ scores and the $\dot{V}O_2$ values, the grouped CoD values and the Bland-Altman plots support the use of these models as a valid means of determining the PL with these groups of players. Future research is needed to determine if the worse fit of the women’s regression equations was based on the protocol used or differences in the level of fitness in sub-populations within the group.

REFERENCES

- 3 Alexiou H, Coutts AJ. A comparison of methods used for quantifying internal training load in women soccer players. *Int J Sports Physiol Perform.* 2008;3(3):320-30.
- 4 Algroy EA, Hetlelid KJ, Seiler S, Stray Pedersen JI. Quantifying training intensity distribution in a group of Norwegian professional soccer players. *Int J Sports Physiol Perform.* 2011;6(1):70-81.
- 5 Altman DG, Bland JM. Measurement in medicine: the analysis of method comparison studies. *Statistician.* 1983;32:307-317.
- 14 Banister EW, Calvert TW. Planning for future performance: implications for long term training. *Can J Appl Sport Sci.* 1980;5(3):170-6.
- 17 Banister EW, Good P, Holman G, Hamilton CL. Modeling the Training Response in Athletes. In Landers DM, editor, *Sport and Elite Performers* (Vol. 3, The 1984 Olympic Scientific Congress Proceedings). Champaign: Human Kinetics. 1986. p. 7-23.
- 24 Bland JM, Altman DG. Statistical methods for assessing agreement between two methods of clinical measurement. *Lancet.* 1986;327(8476):307-10.
- 40 Earnest CP, Jurca R, Church TS, Chicharro JL, Hoyos J, Lucia A. Relation between physical exertion and heart rate variability characteristics in professional cyclists during the Tour of Spain. *Br J Sports Med.* 2004;38(5):568-75.
- 43 Edwards S. *The Heart Rate Monitor Book.* Sacramento, CA: Fleet Feet Press, 1990.
- 51 Foster C. Monitoring training in athletes with reference to overtraining syndrome. *Med Sci Sports Exerc.* 1998;30(7):1164-8.
- 52 Foster C, Daines E, Hector L, Snyder AC, Welsh R. Athletic performance in relation to training load. *Wis Med J.* 1996;95(6):370-4.
- 54 Foster C, Hector LL, Welsh R, Schragger M, Green MA, Snyder AC. Effects of specific versus cross-training on running performance. *Eur J Appl Physiol Occup Physiol.* 1995;70(4):367-72.
- 55 Foster C, Hoyos J, Earnest C, Lucia A. Regulation of energy expenditure during prolonged athletic competition. *Med Sci Sports Exerc.* 2005;37(4):670-5.
- 58 Gabbett TJ, Jenkins DG. Relationship between training load and injury in professional rugby league players. *J Sci Med Sport.* 2011;14(3):204-9.
- 63 González-Haro C, San Millan I, González-de-Suso JM, Galilea P. TRIMP methodological issues. A new accurate methodology. *Med Sci Sports Exerc.* 2009;41(5), 151.
- 69 Hellard P, Avalos M, Lacoste L, Barale F, Chatard JC, Millet GP. Assessing the limitations of the Banister model in monitoring training. *J Sports Sci.* 2006;24(5):509-20.
- 70 Herman L, Foster C, Maher MA, Mikat RP, Porcari JP. Validity and reliability of the session RPE method for monitoring exercise training intensity. *SAJSM,* 2006;18(1):14-17.
- 74 Impellizzeri FM, Rampinini E, Coutts AJ, Sassi A, Marcora SM. Use of RPE-based training load in soccer. *Med Sci Sports Exerc.* 2004;36(6):1042-7.

- 78 Jeong TS, Reilly T, Morton J, Bae SW, Drust B. Quantification of the physiological loading of one week of "pre-season" and one week of "in-season" training in professional soccer players. *J Sports Sci.* 2011;29(11):1161-6.
- 79 Jones A, Doust J. A 1% treadmill grade most accurately reflects the energetic cost of outdoor running. *J Sports Sci.* 1996;14(4):321-327.
- 93 Lounana J, Campion F, Noakes TD, Medelli J. Relationship between %HRmax, %HR reserve, %VO₂max, and %VO₂ reserve in elite cyclists. *Med Sci Sports Exerc.* 2007;39(2):350-7.
- 96 Lucia A, Hoyos J, Santalla A, Earnest C, Chicharro JL. Tour de France versus Vuelta a España: Which is harder? *Med Sci Sports Exerc.* 2003;35(5):872-8.
- 98 Manzi V, Castagna C, Padua E, Lombardo M, D'Ottavio S, Massaro M, Volterrani M, Iellamo F. Dose-response relationship of autonomic nervous system responses to individualized training impulse in marathon runners. *Am J Physiol Heart Circ Physiol.* 2009;296(6):733-40.
- 100 Manzi V, D'Ottavio S, Impellizzeri FM, Chaouachi A, Chamari K, Castagna C. Profile of weekly training load in elite male professional basketball players. *J Strength Cond Res.* 2010;24(5):1399-406.
- 107 Millet GP, Candau RB, Barbier B, Busso T, Rouillon JD, Chatard JC. Modelling the transfers of training effects on performance in elite triathletes. *Int J Sports Med.* 2002;23:55-63.
- 116 Mujika I, Busso T, Lacoste L, Barale F, Geysant A, Chatard J-C. Modeled responses to training and taper in competitive swimmers. *Med Sci Sports Exerc.* 1996;28(2):251-258.
- 120 Padilla S, Mujika I, Santisteban J, Impellizzeri FM, Goiriena JJ. Exercise intensity and load during uphill cycling in professional 3-week races. *Eur J Appl Physiol.* 2008;102(4):431-8.
- 128 Rodríguez-Marroyo JA, García-López J, Juneau CE, Villa JG. Workload demands in professional multi-stage cycling races of varying duration. *Br J Sports Med.* 2009;43(3):180-5.
- 137 Stagno KM, Thatcher R, van Someren KA. A modified TRIMP to quantify the in-season training load of team sport players. *J Sports Sci.* 2007;25(6):629-634.
- 142 Swain DP, Leutholtz BC, King ME, Haas LA, Branch JD. Relationship between % heart rate reserve and % VO₂ reserve in treadmill exercise. *Med Sci Sports Exerc.* 1998;30(2):318-21.
- 144 Takken T, Ribbink A, Heneweer H, Moolenaar H, Wittink H. Workload demand in police officers during mountain bike patrols. *Ergonomics.* 2009;52(2):245-50.
- 147 Thomas L, Mujika I, Busso T. A model study of optimal training reduction during pre-event taper in elite swimmers. *J Sports Sci.* 2008;26(6):643-52.
- 150 Wallace LK, Slattery KM, Coutts AJ. The ecological validity and application of the session-RPE method for quantifying training loads in swimming. *J Strength Cond Res.* 2009;23(1):33-8.
- 153 Wilson, II RW, Goepfinger TS, Wade BA, Snyder AC. Assessment of Multiple Physiological Variables for Use in the Quantification of Physiological Load. 2012.
- 157 Wood RE, Hayter S, Rowbottom D, Stewart I. Applying a mathematical model to training adaptation in a distance runner. *Eur J Appl Physiol.* 2005;94(3):310-6.

ACKNOWLEDGMENTS

Partial funding from Zephyr Technologies, Inc.

CONFLICT OF INTEREST

No conflicts of interest.

Study 3: Comparison of Models for the determination of Physiological Load in NCAA DI Soccer Athletes

Robert W. Wilson, II, MS, CSCS*D, Ann C. Snyder, PhD, CSCS*D

Human Performance Laboratory, Department of Kinesiology, College of Health
Sciences, University of Wisconsin – Milwaukee

Key Words: TRIMPs, training load, heart rate

ABSTRACT

Several models have been presented to calculate the physiological load (PL) of athletes while they train and compete. Few studies have been conducted to compare the scores of the previously presented PL models. Recently, two new models have been devised for quantifying the PL in female (PLQ_{WS}) and male (PLQ_{MS}) collegiate soccer players. The purpose of this study was to compare scores from these new models to the previous PL models using the same dataset. **METHODS:** Heart rate (HR) data from one randomly selected training session completed by each group were entered into the PL models (9 models for the women and 10 models for the men) for determination of their respective PL scores. These scores were then analyzed using a repeated-measures ANOVA (RM-ANOVA) test with a Bonferroni post-hoc analysis, and compared in a pairwise manner to the PLQ models using the Pearson's product moment correlation (r) analysis. **RESULTS:** Most PL models were found to be statistically significantly different from but strongly correlated ($r > 0.60$) with the proposed PLQ models based on the RM-ANOVA and Pearson analyses. **CONCLUSION:** The new models produce statistically different values from the previous models. While there were strong to very strong relationships between the new and old models, they are not interchangeable. **PRACTICAL APPLICATIONS:** When selecting a model to assess the PL of their athletes, coaches need to judiciously select the model that is most similar to their circumstances.

Key Words: TRIMPs, Training load, soccer, heart rate

INTRODUCTION

Sports coaches design their training programs to elicit a peak in performance during a specified period of time, typically a championship tournament or competition. Many of the coaches of high performing and elite level athletes employ a periodized training plan where training volumes and intensities are modulated during different phases to enhance specific abilities. However, a periodized training plan does not provide feedback with regard to the amount of strain, or physiological load (PL), that the athletes experience during the training sessions. Several models have been proposed as a means of assessing this strain.

The earliest PL model was developed by Banister and colleagues (14) as part of their work on predicting sports performance for athletes engaged in “steady-state” sports, like swimming and running. They defined the PL of an exercise session as the stress (i.e., the amount of work to be performed) multiplied by the strain (i.e., the amount of effort put forth as indicated by a physiological variable). They termed the PL value as a TRIMP. Since that time 10 other models of calculating the TRIMP value have been developed. These PL models have operationalized strain differently. Nine of the 10 models utilize a form of HR as the index of physiological strain; the 10th model utilizes a psychometric perception of strain (Table 3.3.1). Other differences in the models include: using an averaged measure of the intensity of the session (TRIMP₈₀ (14), TRIMP₈₆ (17), sRPE (54)), classifying the intensity into distinct zones (TRIMP_{Lucia} (96), HZT (43), TRIMP_{Wood} (157), TRIMP_{mod} (137)), and weighting each HR value (TRIMP_{Millet} (107), TRIMP_i (98), TRIMP_{fit} (63)). The averaged-intensity models (TRIMP₈₀, TRIMP₈₆ and sRPE) use a few values (an average of 3 %HR_{max} values for TRIMP₈₀ and 3 %HRR values for TRIMP₈₆, one RPE value for the activity) as their indication of the strain.

Intuitively these models were suited for steady-state activities, but not for stochastic training sessions, such as occur with soccer, basketball, lacrosse and rugby. These models multiply strain value by the duration of the session in minutes to determine their PL scores.

The zone-based models use varied methods to set their zones, or categories. $TRIMP_{Luica}$ uses the ventilatory threshold (VT) as the differentiate between zones 1 and 2, and the respiratory compensation point (RCP) as the differentiate between stages 2 and 3. The $TRIMP_{Wood}$ model used several different thresholds and relationships between thresholds to set its 5 zones. The $TRIMP_{mod}$ model used the blood lactate concentration ([HLA]) curve as the basis of their model and constructed the 5 zones, with zones 2 and 4 anchored on [HLA] values of 1.5 and 4.0 millimoles per liter ($mmol \cdot l^{-1}$), respectively. The HZT model used the simple approach of decile-based categorical zones, based on $\%HR_{max}$. In all of the zonal models, each zone is assigned a weighting factor. $TRIMP_{Lucia}$ and HZT used arithmetic scaled weighting factors, with the zone 1 (the lowest zone) having a weighting factor of 1 and then increased by 1 with each increase in intensity zone. $TRIMP_{Wood}$ used the approximate lactate value from swimming field tests as the weighting factors for each zone, which resulted in a scale that had both arithmetic and exponential characteristics. The weighting factors for the $TRIMP_{mod}$ were formed by using an exponential equation similar to the method proposed by Banister and colleagues (17). PL scores for the zone models were calculated by multiplying the minutes spent in the zone by its weighting factor and then summing all of those zone values.

The continuous-tracking models (i.e., $TRIMP_{Millet}$, $TRIMP_i$, and $TRIMP_{fit}$) determine a partial PL score for each HR value. A total PL score was then calculated by entering

each HR observed during the period of interest into the model's equation and then summing all of the partial PL scores.

The calculated PL scores were expressed in minute values. However, even though most of the PL scores have been termed TRIMPs and were expressed in the same manner (per minute) few comparisons between these models have been performed.

Most of the comparative studies that have been conducted have correlated one or multiple PL models with the sRPE model in different populations. The relationships between the sRPE model and the TRIMP₈₆, TRIMP_{Lucia}, and HZT models were found to be significant for male soccer players ($r = 0.50 - 0.77$, $r = 0.54 - 0.78$, $r = 0.61 - 0.85$, respectively; $p < 0.01$) (74), elite females soccer players ($r = 0.67 - 0.95$, $r = 0.56 - 0.97$, $r = 0.50 - 0.96$, respectively; $p < 0.01$) (3) and well-trained swimmers ($r = 0.55 - .92$, $r = 0.59 - 0.94$, $r = 0.56 - 0.91$, p not stated) (150). Likewise, male professional basketball players in Europe were found to have primarily strong relationships between their sRPE scores and TRIMP₈₆ and HZT scores ($r = 0.70 - 0.82$, $r = 0.69 - 0.85$, $p < 0.001$) (100). While a visual inspection of PL scores may reveal that the scores are of different magnitudes, only Foster and colleagues (53) have conducted analyses to determine if there were differences between PL scores. They compared the scores from the sRPE and HZT models and found that the PL scores from the sRPE model were significantly greater across a range of running activities for physically active individuals and during collegiate basketball practices.

Two new models for determining the quantity of physiological load (PLQ) for collegiate female (PLQ_{WS}) and male (PLQ_{MS}) soccer players using a continuous-tracking methodology were recently produced (153) and shown to be internally valid against

multiple $\dot{V}O_2$ measures (156). These models were shown to be very strongly related with the $\dot{V}O_2$ measures collected ($r = 0.84 - 1.00$) and thus warrant being considered as accurate models for quantifying the PL of soccer players. In order to understand how these new models related to the previously constructed models, it was necessary to determine if the scores from the previous models differ from and were correlated with the PLQ_{WS} and PLQ_{MS} models.

Therefore, it was the purpose of this study to compare the recently developed (PLQ) models to the previous (PL) models presented by other researchers. It was hypothesized that entering the same data into the new and the previously presented models would result in statistically different scores and a wide range of correlations. These hypotheses were formulated from the analysis of the models and observations of the scores presented in several studies. While a percentile variant of HR is the predominant strain index in these PL models, each model is slightly different from the others. The more similar the models, the more likely the scores are to be similar. Likewise, the less similar the models are mathematically, the more dissimilar and possibly statistically significant the scores would be. We expected that due to the mathematical differences between the models, the correlation coefficients between the PLQ models and the PL models would vary.

METHODS

Experimental Approach to the Problem Members of an National Collegiate Athletics Association (NCAA) Division I (DI) women's and men's soccer teams were brought into the Human Performance Laboratory at the University of Wisconsin – Milwaukee to complete sub-maximal and maximal effort treadmill tests. The female

participants completed a sub-maximal effort treadmill (SM) protocol with a variable start. The initial stage was set at a speed to elicit a HR of approximately $140 \text{ beats} \cdot \text{min}^{-1}$ (Table 3.2.1). The incline was set at 1% (79) and speed was increased by $0.8 \text{ km} \cdot \text{h}^{-1}$ per stage. In contrast, male participants completed a standardized sub-maximal effort treadmill protocol. The incline was set at 1%, initial speed was $6.0 \text{ km} \cdot \text{h}^{-1}$ and was increased by $2.0 \text{ km} \cdot \text{h}^{-1}$ per stage. The duration of the stages in both SM protocols was 6 min. Blood was collected for blood lactate concentration ([HLA]) analysis during the min 6 of each SM stage. The maximal effort treadmill (HMC) protocols started with 0% incline, and increased in speed by $1 \text{ km} \cdot \text{h}^{-1}$ and incline by 2%, alternately, after the first stage. Blood for [HLA] analysis was collected 1 min after the conclusion of the HMC test. All stages were 1 min in duration. Women started at a speed of $6 \text{ km} \cdot \text{h}^{-1}$ and men started at $7 \text{ km} \cdot \text{h}^{-1}$. Female participants completed the SM test prior to their Fall pre-season training and HMC tests were conducted during an off-/ rest week in the middle of the season. Male participants completed SM and HMC protocols prior to their Fall pre-season training on the same day separated by a recovery period. Regression analyses were conducted to determine the best-fit equations for the prediction of [HLA] from %HRR when the data were pooled by team. The mathematical models were labeled PLQ_{WS} for the women's soccer team and PLQ_{MS} for the men's soccer team. (For more information about the testing procedures consult Wilson, Goepfinger, Wade and Snyder (153))

Players then wore Polar Team1 heart rate monitors during their training sessions. Data from one practice session for each group were entered into their respective PLQ model and the other PL models. The resulting PL scores were compared using statistical

tests to determine if the scores were different and how well the scores were related using a correlation analysis technique. Nine of these 10 PL models, also known as TRIMP models, selected utilize a physiological variable (i.e., $\%HR_{max}$ and $\%HRR$) to assess the strain placed on the athletes. Models which characterize training load as an absolute non-physiologically-based indicator or measure of work performed, were not utilized even though some of these models have been classified as TRIMP models. While the sRPE model does not utilize a physiological model of strain, it does use the perception of strain as a factor. Thus, it was included due to its prevalence in the PL literature and the fact that it is the only other PL model to undergo a validity assessment.

Participants Eighteen (n=18) female and eighteen (n=18) male collegiate well-trained NCAA DI soccer players ($\bar{x} \pm s$: age: 19.4 ± 1.1 and 20.1 ± 1.7 yr, weight: 61.5 ± 6.1 and 75.4 ± 10.4 kg, height: 1.67 ± 0.07 and 1.80 ± 0.07 m, BMI: 22.2 ± 1.8 and 23.3 ± 2.0 $kg \cdot m^{-2}$, respectively) participated in this study. All participants were informed of the aims and objectives of the study before completing informed consent and health history documents. This study was approved by the Institutional Review Board of the University of Wisconsin – Milwaukee.

Practice session One session per team was randomly selected for analysis. HR data from these practices were downloaded using Polar ProTrainer 5 (version 5.00.100) Professional Training Software. The data were exported for PL score computation in Microsoft Office Excel 2007 (Microsoft Corporation, Redmond, WA USA).

HR data Each HR value was transformed into a percent of HR reserve (82, $\%HRR$) or percent of maximal HR ($\%HR_{max}$) equivalent (Equations 3.3.1 and 3.3.2) for use in the PL models.

$$\%HRR = (HR_{obs} - HR_{rest}) \cdot (HR_{max} - HR_{rest})^{-1} \quad 3.3.1$$

$$\%HR_{max} = (HR_{max} - HR_{exer}) \cdot HR_{max}^{-1} \quad 3.3.2$$

Where “HR_{obs}” were all of the observed HR data for the analyzed training sessions, “HR_{rest}” was the resting HR value, and “HR_{max}” was the maximum HR. In place of a true resting HR for the HR_{rest} value for each study participant/ athlete, the lowest HR value recorded while wearing the HRM during testing or the first week of training was used. HR_{max} was determined from the maximal effort test that the participant/ athlete completed.

Physiological Load Models and Scores The equations for the previous PL models are presented in Table 3.3.1. The appropriate HR values were entered into the equations in the manner prescribed by the authors with the following three adjustments. First, one HR value was randomly selected from three distinct periods during the training session for averaging and use in the TRIMP₈₀ and TRIMP₈₆ models to ensure that HR values were not selected too closely due to the random selection of time points. Second, due to time constraints placed upon the participants, an RPE score for the session was obtained from the male soccer players 10 min post-practice rather than 30 min post-practice as prescribed by Foster and colleagues (54). This was necessary due to the student-athletes need to attend classes. Third, using polynomial equations as proposed by González-Haro and colleagues (63) produced negative scores. Therefore, exponential equations determined from regression analyses conducted on each individual’s sub-maximal and maximal effort test data (which did not produce these unrealistic values) were used.

Table 3.3.1. Formulae for previous PL models

Category	Models	Equation
Mean	TRIMP ₈₀ (14)	$TRIMP_{80} = T \cdot (\bar{x} \text{ of } 3HR \text{ values} \cdot 100 / HR_{max})$
	TRIMP ₈₆ (17)	$TRIMP_{86} = T \cdot (\bar{x} \text{ of } 3 \%HRR \text{ values}) \cdot y$
	sRPE (54)	$sRPE = T \cdot CR10$
Zones	TRIMP _{Lucia} (96), HZT(43), TRIMP _{Wood} (157), TRIMP _{Mod} (137)	$Score = (t_{z1} \cdot w_{z1}) + (t_{z2} \cdot w_{z2}) + \dots (t_{zn} \cdot w_{zn})$
Continuos	TRIMP _{Millet} (107)	$TRIMP_{Millet} = \sum (sr^{-1} \cdot \%HRR_i \cdot y)$
	TRIMP _{fit} (63)	Individual best-fit exponential regression equation
	TRIMP _i (98)	$TRIMP_i = \sum (sr^{-1} \cdot \%HRR \cdot y_i)$
	PLQ _{WS} (153)	$PLQ_{WS} = \sum [(0.90886 + 0.00705673 \cdot e^{(7.03434 \cdot \%HRR_i)}) \cdot sr^{-1}]$
	PLQ _{MS} (153)	$PLQ_{MS} = \sum [(0.235182 \cdot e^{(3.55248 \cdot \%HRR_i)}) \cdot sr^{-1}]$

Key e = Napierian natural logarithm = 2.71828182845904
 CR10 = Borg's Criterion Referenced 10 point RPE scale
 HR = heart rate
 HR_{max} = maximal heart rate
 %HRR = percent of heart rate reserve
 %HRR_i = individual percent of heart rate reserve values
 n = highest zone number
 sr = sampling rate of HR monitor (i.e., the number of values reported in 1 min)
 sRPE = Rating of Perceived Exertion for a session
 \sum = sum of all calculated values
 t = duration of time in each zone in minutes
 T = duration of exercise session in minutes
 w = weighting factor
 \bar{x} = mean value over the exercise session
 y = intensity factor from general gender specific regression equation for lactate curve ($y_{male} = 0.64 \cdot \%HRR \cdot e^{1.92\%HRR}$, $y_{female} = 0.86 \cdot \%HRR \cdot e^{1.67\%HRR}$)
 y_i = individual best-fit equation for lactate curve
 Z = zone

Statistical analysis. PLQ and PL scores were compared by gender using a repeated measures analysis of variance (RM-ANOVA) with a Bonferroni post-hoc analysis. The degree of relationship between the PLQ scores and the respective scores from the other PL models were analyzed using Pearson's product moment correlations (r). All statistics were computed using IBM SPSS Statistics (v19, IBM Corp, New York) (p < 0.05).

The observed power for the RM-ANOVA analyses was 1.000 for both analyses ($\alpha = 0.05$).

RESULTS

The RM-ANOVA indicated differences between the PLQ scores and the scores from the other PL methodologies for both the PLQ_{WS} and PLQ_{MS} models (PLQ_{WS} $F(1, 17) = 341.07, p < 0.001$; PLQ_{MS} $F(1, 11) = 1307.93, p < 0.001$). Post-hoc analyses revealed that the PLQ score for the female soccer players was significantly different from the TRIMP₈₀, TRIMP_{Lucia}, HZT, TRIMP_{Wood}, TRIMP_{mod}, TRIMP_{Millet} and TRIMP_i scores ($p < 0.01$, Figure 3.3.1). Post-hoc analyses revealed that the PLQ scores for the male soccer players was significantly different from the TRIMP₈₀, TRIMP₈₆, sRPE, TRIMP_{Lucia}, HZT, TRIMP_{Wood}, TRIMP_{mod}, TRIMP_{Millet} and TRIMP_i scores ($p < 0.01$, Figure 3.3.2). Pearson analyses revealed varying correlations and many significant relationships between PLQ and other PL scores (Table 3.3.2). Very strong relationships exist between the PLQ_{WS} scores and TRIMP_{Millet} ($r = 1.00$), TRIMP_{Lucia} ($r = 0.99$), TRIMP_{mod} ($r = 0.97$), HZT ($r = 0.92$), TRIMP_{Wood} ($r = 0.91$), TRIMP₈₆ ($r = 0.79$) and TRIMP₈₀ ($r = 0.72$) scores. The TRIMP_i and TRIMP_{fit} scores have strong relationships with the PLQ_{WS} scores ($r = 0.67$ and $r = 0.60$, respectively). The PLQ_{MS} scores are very strongly related to the TRIMP_{Millet} ($r = 0.99$), TRIMP_{mod} ($r = 0.99$), HZT ($r = 0.98$), TRIMP_{Wood} ($r = 0.97$), TRIMP_i ($r = 0.82$) and TRIMP_{Lucia} ($r = 0.80$) scores. Strong relationships exist between the PLQ_{MS} scores and the TRIMP₈₀ ($r = 0.65$), TRIMP₈₆ ($r = 0.62$) scores. Moderate relationships were found between the PLQ_{MS} scores and the TRIMP_{fit} ($r = 0.50$) and sRPE ($r = 0.50$) scores.

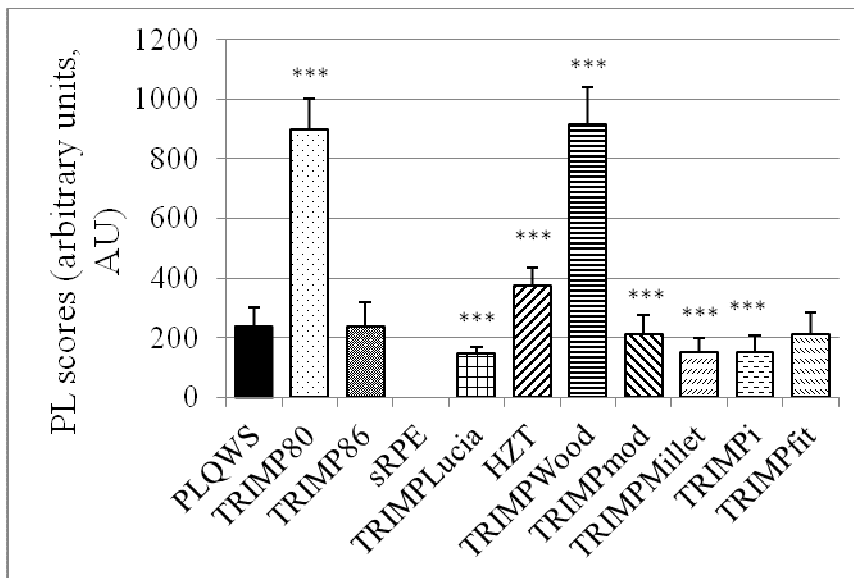

Figure 3.3.1. Mean PL scores for female players. Significantly different from respective PLQ_{WS} value in RM-ANOVA analysis. * $p < 0.05$, ** $p < 0.01$, *** $p < 0.001$.

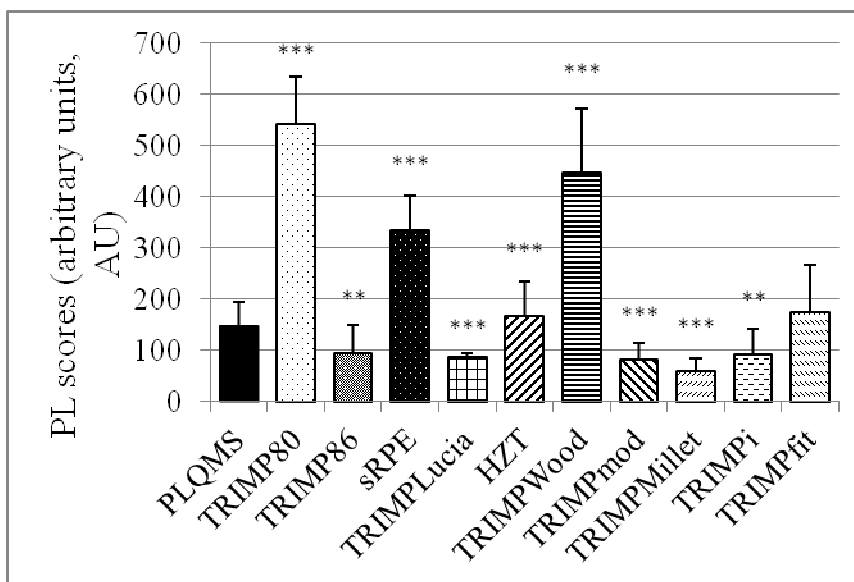

Figure 3.3.2. Mean PL scores for male players. Significantly different from respective PLQ_{MS} value in RM-ANOVA analysis. * $p < 0.05$, ** $p < 0.01$, *** $p < 0.001$.

Table 3.3.2. Pearson product moment correlation coefficients between the scores from PLQ_{WS} and PLQ_{MS} and the other PL models. n = number of individuals for the particular methodology, r = Pearson Product Moment correlation, NC = not calculated. Significantly correlated with respective PLQ value: § p<0.05, §§ p<0.01, §§§ p<0.001.

Models	PLQ _{WS}		PLQ _{MS}	
	n	r	n	r
TRIMP80	18	0.72 ^{§§}	18	0.65 ^{§§}
TRIMP86	18	0.79 ^{§§}	17	0.62 ^{§§}
sRPE	NC	NC	15	0.50
TRIMP _{Lucia}	18	0.99 ^{§§}	18	0.80 ^{§§§}
HZT	18	0.92 ^{§§}	18	0.98 ^{§§§}
TRIMP _{Wood}	18	0.91 ^{§§}	18	0.97 ^{§§§}
TRIMP _{mod}	18	0.97 ^{§§}	17	0.99 ^{§§§}
TRIMP _{Millet}	18	1.00 ^{§§}	18	0.99 ^{§§§}
TRIMP _i	18	0.67 ^{§§}	16	0.82 ^{§§§}
TRIMP _{fit}	18	0.60 ^{§§}	16	0.50 [§]

DISCUSSION

Data from single practice sessions completed by these female and male soccer players were entered into their respective PLQ models and the other PL models. Rating of perceived exertion data were not collected for the female participants, therefore sRPE was not analyzed for this group. The RM-ANOVA test and the post-hoc analyses revealed that significant differences existed between the scores from both of the PLQ models and the other PL models at the 0.01 level. The Pearson correlation coefficients indicated that PLQ scores were strongly related to the other PL scores ($r = 0.60 - 1.00$, $p < 0.001$), except the sRPE and TRIMP_{fit} models for the PLQ_{MS} scores. Therefore, both proposed hypotheses were supported as the models were shown to result in mathematically different values and they were related as indicated by the Pearson correlations values.

These results are consistent with previously presented comparative literature. Strong and very strong Pearson correlation coefficients were found between the different PL

scores (Table 3.3.2). This may be the result of the low intensity but long duration of the practice session. The $TRIMP_{Millet}$ model utilized the same formula as the $TRIMP_{86}$ model but calculated a TRIMP value for every HR value which may explain the weaker correlations between the PLQ scores and the $TRIMP_{86}$ scores. The $TRIMP_{86}$ model utilizes three randomly selected HR values, which could be taken during peak-, moderate- or low-intensity activities, or a combination. The randomness of the selection can be a source of error and as the time point when the HR values were observed/collected varied between individuals, this error could have been increased. By assessing a partial TRIMP value for every HR, the $TRIMP_{Millet}$ model would reduce the affect of erroneous HR values being randomly selected. As the $TRIMP_{86}$ model was originally conceived to be used with individuals completing steady state activities, their averaging of 3 randomly observed HR values would not have presented the same issue as when using this model in more stochastic events.

The Pearson correlation coefficient value for the PLQ_{MS} -sRPE correlation indicated a moderate but non-significant relationship. Also, this Pearson correlation coefficient was tied for the lowest for the men's data. The weaker correlations may also be due to collection of the RPE scores at approximately 10 min after practice and not at the prescribed 30 min, which may have inflated the sRPE scores.

Very strong correlations ($r > 0.80$) may be interpreted as an indication of the consistency of the scores in relation to the other scores. Data that produce a high score in the PLQ model may produce a high score in the corresponding PL model. As such, the PLQ scores from both models correspond very strongly with the $TRIMP_{Millet}$, $TRIMP_{Lucia}$, HZT, and $TRIMP_{Wood}$ models, and the PLQ_{MS} scores correlate very strongly

with the $TRIMP_i$ scores. The lines connecting the corresponding scores between the PLQ_{WS} and $TRIMP_{Millet}$ models do not cross each other (Figure 3.3.3a). This however, does not mean that the scores are interchangeable or that these models can be considered valid measures of PL. By comparison, the scores from the PLQ_{WS} model were not significantly different from the $TRIMP_{fit}$ scores and were strongly correlated ($PLQ_{WS} = 240.79 \pm 61.75$, $TRIMP_{fit} = 213.98 \pm 71.62$, $r = 0.60$) but the slopes of the lines in the line graphs are different and multiple lines cross each other (Figure 3.3.3b) which indicate many discrepancies in the rank-order of the score between the groups.

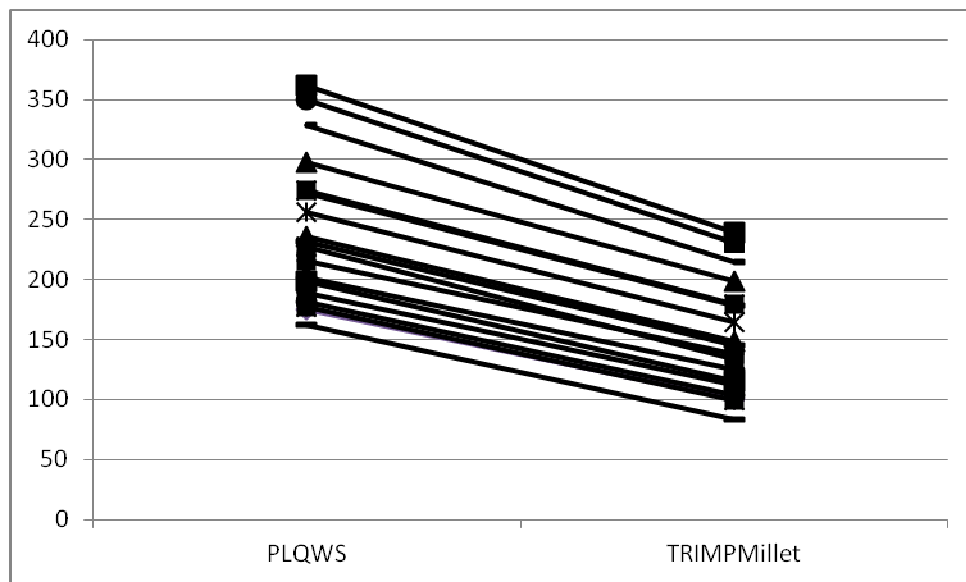

Figure 3.3.3a. Individual line graph of scores from the PLQ_{WS} and $TRIMP_{Millet}$ models. ($r = 1.00$)

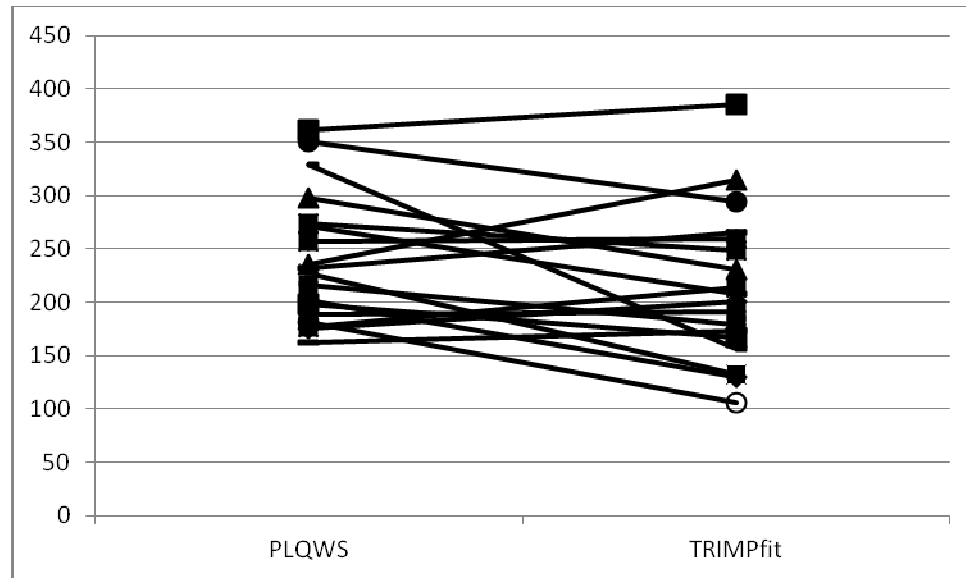

Figure 3.3.3b. Individual line graph of scores from the PLQ_{WS} and TRIMP_{fit} models ($r = 0.60$)

While the PLQ models were strongly and significantly correlated with the majority of the PL scores, they were also significantly different mathematically from those scores. These differences are the result of the mathematical characteristics of the models. While many of the models produced numbers which were relatively close, some of the models produced different scores which could be observed visually. The TRIMP₈₀, sRPE and TRIMP_{Wood} models produced the highest scores. They have large multipliers and are not controlled by an intensity factor. The score of the TRIMP₈₀ model is the product of the average %HR_{max} and the session duration (14). The sRPE scores are the product of the RPE score (i.e., 1 – 10) and the session duration. The TRIMP_{Wood} model utilizes the largest weighting factor scale (157) and thus more time in the higher zones will inflate the PL scores. Banister and colleagues realized that the TRIMP₈₀ scores could be high even if the intensity was low due to a longer duration (17), which is why the TRIMP₈₆ model was created (17). By adding an intensity variable, “y”, based on the non-linear

regression equation of a general lactate curve, the inflation of the score was controlled, which was exhibited in this study. The addition of such an intensity factor to the sRPE model might reduce the scores.

The scores for both of the PLQ models were not different from the $TRIMP_{fit}$ model scores. This may be due to the fact that the $TRIMP_{fit}$ equation is the best-fit equation from each individual and the PLQ model is the best-fit equation for the pooled data from these same subjects. However, the Pearson coefficients between the PLQ scores and the PLQ- $TRIMP_{fit}$ models indicated strong and moderate relationships (PLQ_{WS}: $r = 0.60$ and PLQ_{MS}: $r = 0.50$) and they were lowest of the Pearson correlation values in their respective comparisons. This indicated that while the mean scores were similar, the PL scores from these models were dissimilar in rank-order between the groups (Figure 3.3.3b).

This study and the interpretation of the results are limited by a few factors. First, only one training session per group was analyzed. An analysis of more sessions may allow for trends between the PL models and either exercise session duration or the intensity (or possibly both) to be made. Even after more sessions have been analyzed, generalization of these results should be made with caution due to the small sample sizes of these groups. Second, the participants were well-trained collegiate-level soccer players who train on a daily basis from one female and one male team. Athletes at different levels or in different sports may produce different results. Third, 9 out of 189 (4.76%) data points were missing from the men's analyses. Missing data can sometimes be estimated and entered; however, it was deemed that this could not be done with confidence due to the differences found between and within the models. Last, we adjusted some of the

techniques used to calculate three of the PL models, as stated in the Methods section.

These adjustments were made to ensure that data would be representative, were randomly sampled, and were able to be obtained, not to alter the resulting PL scores.

CONCLUSION

Data from single practice sessions completed by the collegiate female and male soccer players in this study were entered into their respective PLQ models and the other PL models. The statistical analyses of the resulting scores indicated that the PLQ models were consistently different from but significantly and strongly and very strongly related to most of the PL models, which partially support our hypothesis. These relationships between the PLQ models and the PL models indicate that some individual scores have approximately the same rank-order between models even though they have different magnitudes. However, the PLQ and PL scores are not interchangeable, even when the correlations are very strong.

PRACTICAL APPLICATIONS

Using a PL model to track the intensity experienced by athletes can help coaches ascertain the level of strain that the athletes undergo during a session, the level of recovery between sessions, and their level of fitness. This study indicates that there were differences in the scales of some of these PL models and in the magnitude of individual scores depending on the model being used. Therefore, coaches need to determine which model is most appropriate for their sports and their athletes. Also, due to the different

magnitudes of the scores produced by these PL models, it is not advisable to compare the PL scores produced by different models.

REFERENCES

- 3 Alexiou H, Coutts AJ. A comparison of methods used for quantifying internal training load in women soccer players. *Int J Sports Physiol Perform.* 2008;3(3):320-30.
- 15 Banister, EW, Calvert TW, Savage MV, Bach TM. A systems model of training for athletic performance. *Aust J Sp Meds.*1975;7:57-61.
- 17 Banister EW, Good P, Holman G, Hamilton CL. Modeling the Training Response in Athletes. In Landers DM, editor, *Sport and Elite Performers* (Vol. 3, The 1984 Olympic Scientific Congress Proceedings). Champaign: Human Kinetics. 1986. p. 7-23.
- 43 Edwards S. *The Heart Rate Monitor Book*. Sacramento, CA: Fleet Feet Press, 1990.
- 53 Foster C, Florhaug JA, Franklin J, Gottschall L, Hrovatin LA, Parker S, Doleshal P, Dodge C. A new approach to monitoring exercise training. *J Strength Cond Res.* 2001;15(1):109-15.
- 54 Foster C, Hector LL, Welsh R, Schragger M, Green MA, Snyder AC. Effects of specific versus cross-training on running performance. *Eur J Appl Physiol Occup Physiol.* 1995;70(4):367-72.
- 63 González-Haro C, San Millan I, González-de-Suso JM, Galilea P. TRIMP methodological issues. A new accurate methodology. *Med Sci Sports Exerc.* 2009;41(5), 151.
- 74 Impellizzeri FM, Rampinini E, Coutts AJ, Sassi A, Marcora SM. Use of RPE-based training load in soccer. *Med Sci Sports Exerc.* 2004;36(6):1042-7.
- 96 Lucia A, Hoyos J, Santalla A, Earnest C, Chicharro JL. Tour de France versus Vuelta a España: Which is harder? *Med Sci Sports Exerc.* 2003;35(5):872-8.
- 98 Manzi V, Castagna C, Padua E, Lombardo M, D'Ottavio S, Massaro M, Volterrani M, Iellamo F. Dose-response relationship of autonomic nervous system responses to individualized training impulse in marathon runners. *Am J Physiol Heart Circ Physiol.* 2009;296(6):733-40.
- 107 Millet GP, Candau RB, Barbier B, Busso T, Rouillon JD, Chatard JC. Modelling the transfers of training effects on performance in elite triathletes. *Int J Sports Med.* 2002;23:55–63.
- 137 Stagno KM, Thatcher R, van Someren KA. A modified TRIMP to quantify the in-season training load of team sport players. *J Sports Sci.* 2007;25(6):629-634.
- 153 Wilson, II RW, Goepfinger TS, Wade BA, Snyder AC. *Assessment of Multiple Physiological Variables for Use in the Quantification of Physiological Load.* 2012.
- 156 Wilson, II RW, Snyder AC. *Validation of Model for Determination of the Physiological Load of Collegiate Soccer Players.* 2012.
- 157 Wood RE, Hayter S, Rowbottom D, Stewart I. Applying a mathematical model to training adaptation in a distance runner. *Eur J Appl Physiol.* 2005;94(3):310-6.

Acknowledgments

This study was partially funded by Zephyr Technologies, Inc.

SECTION 4: Discussion

The overall aim of this research project was to devise valid mathematical models for quantifying the physiological load (PL) of practices and competitions for female and male National Collegiate Athletic Association (NCAA) Division I (DI) collegiate soccer players (female's model: PLQ_{WS} , male's model: PLQ_{MS}). Data from sub-maximal and maximal effort tests were used to construct these models. After development of the PLQ models, they were shown to be consistent and internally valid when comparing the PLQ scores to 4 different expressions of the volume of oxygen consumed ($\dot{V}O_2$), the gold standard of performed work. Last, comparisons of the scores from the PLQ models to the PL scores from the previous models occurred. In combination these three studies have produced models which are physiologically realistic, have a very strong relationship with the gold standard of work performed and are unique when compared to the models previously presented in the research literature for the assessment of PL.

The first study proposed that several variables which can readily be collected in a field setting be considered for incorporation into a model for determining the PL of NCAA DI female and male soccer players. It was hypothesized that a multi-variate model would produce a better fitting equation than a single variable equation, that the movement and ventilation rate variables would be incorporated into the new model, and that the model constructed for the men (PLQ_{MS}) would produce a lower score than the model constructed for the women (PLQ_{WS}) for the same bout of exercise. Players were brought into the lab to complete sub-maximal and maximal effort tests. The sub-maximal protocol was standardized for the men to enhance comparability of results between participants. Also, due to a greater level of fitness revealed from pilot testing of the male players, the maximal effort protocol was adjusted to result in a testing time of 10 – 12

minutes. These adjustments to the testing protocols should not have affected the results as the individual responses to the workloads, as indicated by the blood lactate values, were the basis of the model. The linear and non-linear analyses lead to the determination that exponential formulae produced the best-fit equations for the PLQ_{WS} and PLQ_{MS} participants. An analysis of these models indicated that percent of heart rate reserve (%HRR) was the only predictor variable. Therefore, the first two hypotheses were not supported. A paired-sample *t*-test revealed that the higher scores from the PLQ_{MS} model were significantly different from the scores from the PLQ_{WS} model when the same data were entered into each equation. Therefore, the models were deemed to be different. Thus, the third hypothesis was partially supported in that the models were different and partially unsupported in that the PLQ_{MS} scores were not lower at the same intensities.

The second study was designed to compare 4 expressions of $\dot{V}O_2$ to the scores from the proposed models. It was hypothesized that there would be a strong to very strong relationship between the PLQ scores and the $\dot{V}O_2$ values and a high level of agreement between the measured and predicted objective measure of physical work. Pearson product moment correlations were conducted between the PLQ scores and $\dot{V}O_2$ as expressed absolutely ($l \cdot \text{min}^{-1}$, $\dot{V}O_{2\text{-abs}}$), relative to bodyweight ($\text{ml} \cdot \text{min}^{-1} \cdot \text{kg}^{-1}$, $\dot{V}O_{2\text{-rel}}$), as a percent of maximal oxygen uptake ($\%VO_{2\text{max}}$) and as a percentage of oxygen uptake reserve ($\%VO_{2R}$) from the sub-maximal effort tests. Analyses indicated that the $\dot{V}O_2$ variables were very strongly related on an individual level for both groups, at a very strong level at a group level for the men and at a moderate level at a group level for the women. While the variable-start protocol, used with the female soccer players, was good for building the original model as it provided many data points, these data were not

different in physiological response at lower workloads. Therefore, when the validation analyses were conducted, the pooling of scores at the lower workload/ intensities reduced the Pearson correlation coefficients (r) and coefficients of determination (R^2) values.

Bland-Altman plots also showed a high degree of agreement between the measured $\dot{V}O_2$ values and those predicted from the regression equations. A tendency to under-predict $\dot{V}O_2$ values at low intensities and over-predict $\dot{V}O_2$ values at higher intensities was found in the women's data, which may be due to the "pooling" of intensities scores at lower workloads. This under- and over-prediction of $\dot{V}O_2$ was not evident in the men's Bland-Altman plots.

The aim of the last study was to compare the PLQ scores with the PL scores from the previous models. It was hypothesized that there would be a wide range of correlations between the PLQ scores and the other PL scores for each group. Data were analyzed to determine if there were differences in the scores using a repeated measures analysis of variance test with a Bonferroni adjustment to the post-hoc analyses. Pearson product moment correlations (Pearson) were conducted to determine how related the data were. The post-hoc analyses determined that many of the PL scores were different from the respective PLQ scores. Pearson analyses revealed that the scores of most of the PL models were at least strongly related to the PLQ scores.

Thus, these studies present two models for the determination of PL for NCAA DI soccer players which are valid on an individual and a group level and distinct from most of the previously presented models. Therefore, when taken collectively, these analyses add a more detailed analysis of these models than has been presented previously in the literature.

Most of the PL models set out to use a given predictor variable (14, 17, 54, 96, 43, 157, 137, 107, 98, 63) rather than explore other potentially viable predictors. This was probably due to the state of the technology (or the access to current technology) at the time that the studies were conducted. Therefore, it makes sense that a transformed version of HR was the predominant variable in the models. The sRPE model (54) was an attempt to further simplify data collection by removing the need for a technological apparatus. However, when this was done, the ability to objectively assess the physiological load was lost and replaced with a subject interpretation of physiological strain, which has not been validated for activities which take place over a prolonged period of time. The regression analyses used to determine the PLQ models resulted in %HRR as the best predictor of the [HLa] curve for the group of female participants. Until better tests which allow for these other variables to be interpretable are created, a form of HR may be the best predictor.

The PL models have been characterized and presented based on the similarity in the way in which the strain was quantified. The PLQ models are continuous-tracking models and therefore are similar in approach to the $TRIMP_{Millet}$ (107), $TRIMP_{fit}$ (63) and $TRIMP_i$ (98) models. The $TRIMP_{Millet}$ and $TRIMP_i$ models are similar in that they use %HRR as the strain variable, and have a moderating intensity (e.g., “k” and “ y_i ”, respectively) factor. $TRIMP_{Millet}$ uses generic values in its “k” factor, while $TRIMP_i$ uses unique values for each individual in its “ y_i ” factor. As the generic “k” factor is not specific to (and maybe not even realistic for) our groups, the models produced significantly different PL scores from the PLQ scores produced. For our data the “ y_i ” factor was either an exponential or a second-degree polynomial equation. The utilization of a second-degree

polynomial equation may have lead to negative numbers for some of the participants, which were not included in the total TRIMP score but did present a loss of data. This may be a reason for the lower group $TRIMP_i$ scores. The manner in which we adjusted the $TRIMP_{fit}$ model, to prevent the calculation of unrealistic values, resulted in the best-fit exponential equation being used.

However, the PLQ scores were different from the scores from the $TRIMP_{Millet}$ (107) and $TRIMP_i$ (98) models, but similar to the $TRIMP_{fit}$ (63) model scores. This may be due to the fact that the $TRIMP_{fit}$ equation is the best-fit equation from each individual and the PLQ model is the best-fit equation for the pooled data from these same subjects.

The Pearson correlation coefficient values were significant and indicated a very strong relationship between the $TRIMP_{Millet}$ and PLQ scores for both groups. The Pearson correlation coefficient values also indicated strong and very strong relationships between the $TRIMP_i$ and PLQ scores for the women and men, respectively with the scores between the models being significantly related. However, while the Pearson correlation coefficient values between the PLQ and $TRIMP_{fit}$ models indicated strong and moderate relationships between the scores (PLQ_{WS} $r = 0.60$ and PLQ_{MS} $r = 0.50$) they were the lowest of the r values in their respective comparisons. This indicated that while the mean scores were similar, the PL scores from these models for each individual were not the same from each equation and that the scores differ in magnitude to the other scores between the models.

The levels of Pearson coefficients in the validation analysis at the individual level with the measures of $\dot{V}O_2$ were very strong for both groups. There was an understandable and expected drop in the correlation when the data was pooled by team.

The Pearson correlation value for the women however dropped more than it did for the men. This was most likely due to the differences between the sub-maximal testing protocols. With the women we used a variable start protocol, where the initial stage was at a speed that elicited a HR of $\sim 140 \text{ beats} \cdot \text{min}^{-1}$ and an increase in speed of $0.8 \text{ km} \cdot \text{h}^{-1}$. The combination of the low starting speed and small increases in speed led to a number of stages at low levels of strain with little difference between some of the early stages, and therefore a “pooling” of data at the lower workloads. This “pooling” of data was not apparent with the men’s data. The men’s tests had a fixed starting speed and a larger increase in speed ($2 \text{ km} \cdot \text{h}^{-1}$) between stages. It is hypothesized that having the women complete a similar fixed protocol with larger increases in speed will enhance the correlations by reducing the “pooling” in the early stages. Work will need to be performed to devise the most appropriate starting points and amount of increase in speed for the sub-maximal effort test. The HMC protocol has already been differentiated while the degree of increase in speed and incline are the same between the two protocols, the women started at a lower speed (the HMC10 protocol).

Validation assessments have only been conducted on these PLQ models and the sRPE model. While assessment of the sRPE model indicated a strong relationship between the sRPE scores and the $\dot{V}O_2$ values obtained, the coefficients of determination are lower than were obtained with the PLQ models. This may be due to the rigidity of the CR-10 RPE scale (the strain index for this model) and the magnitude of the duration of the training session. RPE scores are reported in increments of 0.5. If we assume a conservative variation in RPE scores of 1.0 ($\bar{x} = 4.0$) for a 120 min training session, the range of scores is 360 to 600 units and they are not necessarily normally distributed.

Rather there are a number of scores at 360, 480 and 600. The addition of an intensity factor similar to what was introduced in the TRIMP₈₆ model might be desirable, though methodologically problematic. Another means of allowing scores to be less fixed, would be to allow for RPE scores to be reported on an increment of 0.1. This solution may lead to reliability and validity issues. The correlation between the PLQ models and the $\dot{V}O_2$ measures may have been higher due to the fact that we compared the PLQ scores to the $\dot{V}O_2$ values from the same physiological tests.

The PLQ_{WS} and PLQ_{MS} models presented in this research have been shown to be internally valid predictors of physiological load of these NCAA DI soccer athletes. The scores produced by these models are different from the other models which have been previously reported and therefore cannot be used interchangeably and the comparison of scores from different models is not advised at this time. While these models are not generalizable due to the small sample sizes, the continuous-tracking approach used to generate these PLQ models should be employed by others when developing new PLQ models.

SECTION 5: Conclusion

The ability to assess the physiological load of athletes is of practical importance to athletes and coaches in that it would allow them to understand how the athletes are responding to the imposed demands of the training session planned by the coach. Therefore, PL models need to be able to recognize the changes in intensity that occur during training and competitions. While PL models which are responsive have been proposed, they have not been subjected to validation assessments. The PLQ models presented produced scores for each group that are very strongly related to the expressions of $\dot{V}O_2$ calculated. Therefore, we present these models for use in assessing the physiological load of female and male NCAA DI soccer players.

SECTION 6: Future directions

This work contributes to the body of literature in the area of physiological load assessment. However, questions still are left to be answered. Some of these questions were not able to be fully answered by these studies and others have arisen due to these studies. From these studies, we propose that the following studies and or analyses of the current data be performed to further ground the quantification of physiological load in scientific fact rather than in conjecture and purely intuitive logic.

- Develop field tests to ascertain if the excluded variables can be incorporated into the PLQ models.
- Generate PLQ models based on data from both variable- and fixed-start sub-maximal effort protocols from the same individuals to determine if there is a difference between the models
- Collect data on more teams at the NCAA DI level and then at other levels
 - This would allow for an analysis of the validity of the PLQ_{WS} model as it relates to the $\% \dot{V}O_2R$ and $\% \dot{V}O_{2max}$ values.
- Collect data on teams that engage in similar types of movement patterns and work-rest ratios during competitions
- Explore the possibility of a difference in relationship based on correlations between the gender of the participants and the PL model used.
- Conduct Pearson correlation analyses between all of the PL models
- Assess the validity and reliability of the use of RPE on steady-state and stochastic exercise session lasting >60 min

SECTION 7: References

- 1 Achten J, Jeukendrup AE. Heart rate monitoring: Applications and limitations. *Sports Med.* 2003;33(7):517-38.
- 2 Aduen J, Bernstein WK, Khastgir T, Miller J, Kerzner R, Bhatiani A, Lustgarten J, Bassin AS, Davison L, Chernow B. The use and clinical importance of a substrate-specific electrode for rapid determination of blood lactate concentrations. *JAMA.* 1994;272(21):1678-85.
- 3 Alexiou H, Coutts AJ. A comparison of methods used for quantifying internal training load in women soccer players. *Int J Sports Physiol Perform.* 2008;3(3):320-30.
- 4 Algroy EA, Hetlelid KJ, Seiler S, Stray Pedersen JI. Quantifying training intensity distribution in a group of Norwegian professional soccer players. *Int J Sports Physiol Perform.* 2011;6(1):70-81.
- 5 Altman DG, Bland JM. Measurement in medicine: the analysis of method comparison studies. *Statistician.* 1983;32:307-317.
- 6 American College of Sports Medicine. Position Stand: The recommended quantity and quality of exercise for developing and maintaining cardiorespiratory and muscular fitness, and flexibility in healthy adults. *Med Sci Sports Exerc.* 1998;30(6):975-91.
- 7 Anglem N, Lucas SJ, Rose EA, Cotter JD. Mood, illness and injury responses and recovery with adventure racing. *Wilderness Environ Med.* 2008;19(1):30-8.
- 8 Anonymous. Diabetes mellitus and exercise. *Med Sci Sports Exerc.* 1997;29(12):I-VI.
- 9 Askanazi J, Milic-Emili J, Broell JR, Hyman AI, Kinney JM. Influence of exercise and CO₂ on breathing pattern in normal man. *J Appl Physiol: Respirat Environ Exer Physiol.* 1979;47(1):192-6.
- 10 Astrand P, Rodahl K. *Textbook of Work Physiology.* 2nd ed. New York: McGraw-Hill Book Co. 1977. 681 p.
- 11 Australian Sports Commission. *Physiological Tests for Elite Athletes.* Champaign: Human Kinetics. 2000. 480 p.
- 12 Avalos M, Hellard P, Chatard JC. Modeling the training-performance relationship using a mixed model in elite swimmers. *Med Sci Sports Exerc.* 2003;35(5):838-46.
- 13 Bangsbo J. The physiology of soccer: with special reference to intense intermittent exercise. *Acta Physiol Scand.* 1994;151(S619):1-155.
- 14 Banister EW, Calvert TW. Planning for future performance: implications for long term training. *Can J Appl Sport Sci.* 1980;5(3):170-6.
- 15 Banister, EW, Calvert TW, Savage MV, Bach TM. A systems model of training for athletic performance. *Aust J Sp Meds.* 1975;7:57-61.
- 16 Banister EW, Carter JB, Zarkadas PC. Training theory and taper: Validation in triathlon athletes. *Eur J Appl Physiol Occup Physiol.* 1999;79(2):182-91.
- 17 Banister EW, Good P, Holman G, Hamilton CL. Modeling the Training Response in Athletes. In Landers DM, editor, *Sport and Elite Performers* (Vol. 3, The 1984 Olympic Scientific Congress Proceedings). Champaign: Human Kinetics. 1986. p. 7-23.

- 18 Banister EW, Wenger HA. Monitoring training. In MacDougall JD, Wenger HA, Green HJ, editors, *Physiological Testing of the Elite Athlete* Ithaca, NY: Movement Publications. 1982. p.163-70.
- 19 Barron JL, Noakes TD, Levy W, Smith C, Millar RP. Hypothalamic dysfunction in overtrained athletes. *J Clin Endocrinol Metab.* 1985;60(4):803-6.
- 20 Bartlett JD, Close GL, MacLaren DPM, Gregson W, Drust B, Morton JP. High-intensity interval running is perceived to be more enjoyable than moderate-intensity continuous exercise: implications for exercise adherence. *J Sport Sci.* 2011;29(6):547-53.
- 21 Best RW, Steinhardt MA. The accuracy of children's counting of exercise heart rates. *Pediatr Exerc Sci.* 1991;3(3):229-237.
- 22 Bishop PA, Smith JF, Kime JC, Mayo JM, Tin YH. Comparison of a manual and an automated enzymatic technique for determining blood lactate concentrations. *Int J Sports Med.* 1992;13(1):36-9.
- 23 Blair SN, Kohl HW, Paffenbarger RS, Clark DG, Cooper KH, Gibbons LW. Physical-fitness and All-cause mortality - A prospective-study of healthy-men and women. *JAMA.* 1989;262(17):2395-2401.
- 24 Bland JM, Altman DG. Statistical methods for assessing agreement between two methods of clinical measurement. *Lancet.* 1986;327(8476):307-10.
- 25 Bompa TO. *Periodization Training: Theory and Methodology*, 4th ed. Human Kinetics, Champaign, IL. 1999. 424 p.
- 26 Bompa T, Haff GG. *Periodization: Theory and Methodology of Training*. 5th ed. Human Kinetics, Champaign, IL, 2009. 424 p.
- 27 Borg G. *Borg's Perceived Exertion and Pain Scales*. Human Kinetics, Champaign, IL. 1998. 104 p.
- 28 Borg G, Ljunggren G, Ceci R. The increase of perceived exertion, aches and pains in the legs, heart rate and blood lactate during exercise on a bicycle ergometer. *Eur J Appl Physiol.* 1985;54:343-9.
- 29 Bradley PS, Di Mascio M, Peart D, Olsen P, Sheldon B. High-Intensity Activity Profiles of Elite Soccer Players at Different Performance Levels. *J Strength Cond Res.* 2010;24(9):2343-51.
- 30 Busso T, Häkkinen K, Pakarinen A, Carasso C, Lacour JR, Komi PV, Kauhanen H. A systems model of training responses and its relationship to hormonal responses in elite weight-lifters. *Eur J Appl Physiol Occup Physiol.* 1990;61(1-2):48-54.
- 31 Calvert TW, Banister EW, Savage MV, Bach T A Systems Model of the Effects of Training on Physical Performance. *IEEE Transactions on Systems, Man, and Cybernetics*, 1976;6(2):94-102.
- 32 Capranica L, Tessitore A, Guidetti L., Figura F. Heart rate and match analysis in pre-pubescent soccer players. *J Sport Sci.* 2001;19(6):379-384.
- 33 Caretti DM, Szlyk PC, Sils IV. Effects of exercise modality on patterns of ventilation and respiratory timing. *Resp Physiol.* 1992;90(2):201-211.
- 34 Carrol T, Godsen R, Tangeman C. The Polar Vantage XL heart rate monitor: An analysis of its internal consistency and computer interface. *Med Sci Sports Exerc.* 1991;23(4):14.

- 35 Caspersen CJ, Powell KE, Christenson GM. Physical activity, exercise and physical fitness: Definitions and distinctions for health-related research. *Public Health Reports*. 1985;100(2): 126-131.
- 36 Centers for Disease Control. *2008 Physical Activity Guidelines for Americans*. Atlanta, GA: Centers for Disease Control, United States Department of Health and Human Services; 2008. 76 p. Available from: <http://www.health.gov/paguidelines/pdf/paguide.pdf>.
- 37 Chiu LZF, Barnes JL. The fitness-fatigue model revisited: Implications for planning short- and long-term training. *Strength Cond J*. 2003;25(6):42-51.
- 38 Dinas PC, Koutedakis Y, Flouris AD. Effects of exercise and physical activity on depression. *Irish J Med Sci*, 2011;180(2):319-325.
- 39 Durant RH, Baranowski T, Davis H, Rhodes T, Thompson WO, Greaves KA, Puhl J. Reliability and variability of indicators of heart-rate monitoring in children. *Med Sci Sports Exerc*. 1993;25(3):389-395.
- 40 Earnest CP, Jurca R, Church TS, Chicharro JL, Hoyos J, Lucia A. Relation between physical exertion and heart rate variability characteristics in professional cyclists during the Tour of Spain. *Br J Sports Med*. 2004;38(5):568-75.
- 41 Earnest CP, Foster C, Hoyos J, Muniesa CA, Santalla A, Lucia A. Time trial exertion traits of cycling's Grand Tours. *Int J Sports Med*. 2009;30(4):240-4.
- 42 Ebbeling CB, Ebbeling CJ, Ward A, Rippe JM. Comparison between palpated heart rates and heart rates observed using the polar favor heart rate monitor during an aerobics exercise class. Report to Polar Electro, No. EPNL - 1991-010, 1991
- 43 Edwards S. *The Heart Rate Monitor Book*. Sacramento, CA: Fleet Feet Press, 1990.
- 44 Ekblom B. Applied physiology of soccer. *Sports Med*. 1986;3(1): 50-60.
- 45 Eniseler N. Heart rate and blood lactate concentrations as predictors of physiological load on elite soccer players during various soccer training activities. *J Strength Cond Res*. 2005;19(4):799-804.
- 46 Esposito F, Impellizzeri FM, Margonato V, Vanni R, Pizzini G, Veicsteinas A. Validity of heart rate as an indicator of aerobic demand during soccer activities in amateur soccer players. *Eur J Appl Physiol*. 2004; 93(1-2):167-72.
- 47 Esteve-Lanao J, San Juan AF, Earnest CP, Foster C, Lucia A. How do endurance runners actually train? Relationship with competition performance. *Med Sci Sports Exerc*. 2005;37(3):496-504.
- 48 Evans, JD. *Straightforward statistics for the behavioral sciences*. Pacific Grove (CA): Brooks/Cole Publishing, 1996. 634 p.
- 49 Faude O, Kellmann M, Ammann T, Schnitzker R, Meyer T. Seasonal changes in stress indicators in high level football. *Int J Sports Med*. 2011;32(4):259-65.
- 50 Fitzgerald L. Overtraining increases the susceptibility to infection. *Int J Sports Med*. 1991;12(S1):S5-8.
- 51 Foster C. Monitoring training in athletes with reference to overtraining syndrome. *Med Sci Sports Exerc*. 1998;30(7):1164-8.
- 52 Foster C, Daines E, Hector L, Snyder AC, Welsh R. Athletic performance in relation to training load. *Wis Med J*. 1996;95(6):370-4.

- 53 Foster C, Florhaug JA, Franklin J, Gottschall L, Hrovatin LA, Parker S, Doleshal P, Dodge C. A new approach to monitoring exercise training. *J Strength Cond Res.* 2001;15(1):109-15.
- 54 Foster C, Hector LL, Welsh R, Schrage M, Green MA, Snyder AC. Effects of specific versus cross-training on running performance. *Eur J Appl Physiol Occup Physiol.* 1995;70(4):367-72.
- 55 Foster C, Hoyos J, Earnest C, Lucia A. Regulation of energy expenditure during prolonged athletic competition. *Med Sci Sports Exerc.* 2005;37(4):670-5.
- 56 Fricker PA, Pyne DB, Saunders PU, Cox AJ, Gleeson M, Telford RD. Influence of training loads on patterns of illness in elite distance runners. *Clin J Sport Med.* 2005;15(4):246-52.
- 57 Gabbett TJ, Domrow N. Relationships between training load, injury, and fitness in sub-elite collision sport athletes. *J Sports Sci.* 2007;25(13):1507-19.
- 58 Gabbett TJ, Jenkins DG. Relationship between training load and injury in professional rugby league players. *J Sci Med Sport.* 2011;14(3):204-9.
- 59 Gabbett TJ, Mulvey MJ. Time-motion analysis of small-sided training games and competition in elite women soccer players. *J Strength Cond Res.* 2008;22(2):543-52.
- 60 Garhammer, J. Periodization of strength training for athletes. *Track Tech.* 1979;73:2398-9.
- 61 Glman MB. The use of heart rate to monitor the intensity of endurance training. *Sports Med.* 1996;21(2):73-9.
- 62 Gollnick PD, Bayly WM, Hodgson DR. Exercise intensity, training, diet, and lactate concentration in muscle and blood. *Med Sci Sports Exerc.* 1986;18(3):334-40
- 63 González-Haro C, San Millan I, González-de-Suso JM, Galilea P. TRIMP methodological issues. A new accurate methodology. *Med Sci Sports Exerc.* 2009;41(5), 151.
- 64 Greist JH, Klein MH, Eischens RR, Gurman AS, Morgan WJ. Running as treatment for depression. *Compr Psychiat.* 1979;29: 41-54.
- 65 Gutman MC, Pollock ML, Foster C, Schmidt D. Training stress in Olympic speedskaters. A psychological perspective. *Physician Sportsmed.* 1984;12, 45-57.
- 66 Hackney A, Pearman S, Nowacki J. Physiological profiles of overtrained and stale athletes: A review. *J Appl Sport Psych.* 1990;2(1):21-33
- 67 Hannum SM, Kasch FW. Acute postexercise blood pressure response of hypertensive and normotensive men. *Scand J Sports Med* 1981;3:1115- 27.
- 68 Helgerud J, Engen LC, Wisloff U, Hoff J. Aerobic endurance training improves soccer performance. *Med Sci Sports Exerc.* 2001;33(11):1925-1931.
- 69 Hellard P, Avalos M, Lacoste L, Barale F, Chatard JC, Millet GP. Assessing the limitations of the Banister model in monitoring training. *J Sports Sci.* 2006;24(5):509-20.
- 70 Herman L, Foster C, Maher MA, Mikat RP, Porcari JP. Validity and reliability of the session RPE method for monitoring exercise training intensity. *SAJSM,* 2006;18(1):14-17.
- 71 Hicks AL, Kent-Braun J, Ditor DS. Sex Differences in Human Skeletal Muscle Fatigue. *Exer Sport Sci Rev.* 2001;29(3):109-112.

- 72 Hoff J, Wisløff U, Engen LC, Kemi OJ, Helgerud J. Soccer specific aerobic endurance training. *Br J Sports Med.* 2002;36(3):218-221.
- 73 Hoffman J. *Norms for Fitness, Performance and Health.* Champaign: Human Kinetics; 2006. 223 p.
- 74 Impellizzeri FM, Rampinini E, Coutts AJ, Sassi A, Marcora SM. Use of RPE-based training load in soccer. *Med Sci Sports Exerc.* 2004;36(6):1042-7.
- 75 Inbar O, Oten A, Scheinowitz M, Rotstein A, Dlin R, Casaburi R. Normal cardiopulmonary responses during incremental exercise in 20-70-yr-old men. *Med Sci Sport Exerc.* 1994;26(5):538-46.
- 76 Iwasaki K, Zhang R, Zuckerman JH, Levine BD. Dose-response relationship of the cardiovascular adaptation to endurance training in healthy adults: How much training for what benefit? *J Appl Physiol.* 2003;95(4):1575-83.
- 77 Jacobs I, Westlin N, Karlsson J, Rasmusson M, Houghton B. Muscle glycogen and diet in elite soccer players. *Eur J Appl Physiol Occup Physiol.* 1982;48(3):297-302.
- 78 Jeong TS, Reilly T, Morton J, Bae SW, Drust B. Quantification of the physiological loading of one week of "pre-season" and one week of "in-season" training in professional soccer players. *J Sports Sci.* 2011;29(11):1161-6.
- 79 Jones A, Doust J. A 1% treadmill grade most accurately reflects the energetic cost of outdoor running. *J Sports Sci.* 1996;14(4):321-327.
- 80 Kalapotharakos VI, Ziogas G, Tokmakidis SP. Seasonal aerobic performance variations in elite soccer players. *J Strength Cond Res.* 2011;25(6):1502-7.
- 81 Karvonen J, Chwalbinska-Monet J, Säynäjäkangas S. Comparison of heart rates measured by ECG and microcomputer. *Physician and Sport Med,* 1984;12(6): 65-69.
- 82 Karvonen J, Vuorimaa T. Heart rate and exercise intensity during sports activities. Practical application. *Sports Med.* 1988;5(5):303-11.
- 83 Kellmann M, Kallus KW. Mood, recovery-stress state and regeneration. In Lehmann M, Foster C, Gastmann U, Keizer H, Steinacker JM, editors, *Overload, fatigue, performance incompetence and regeneration in sport.* New York: Plenum. 1999. p. 101-117.
- 84 Kingsley M, Lewis MJ, Marson RE. Comparison of Polar 810s and an ambulatory ECG system for RR interval measurement during progressive exercise. *Int J Sports Med.* 2005;26(1):39-44.
- 85 Kiviniemi AM, Hautala AJ, Kinnunen H, Tulppo MP. Endurance training guided individually by daily heart rate variability measurements. *Eur J Appl Physiol.* 2007;101(6):743-51.
- 86 Köklü Y, Aşçi A, Koçak FU, Alemdaroğlu U, Dündar U. Comparison of the Physiological Responses to Different Small-Sided Games in Elite Young Soccer Players. *J Strength Cond Res.* 2011;25(6):1522-1528.
- 87 Krstrup P, Mohr M, Steensberg A, Bencke J, Kjaer M, Bangsbo J. Muscle and blood metabolites during a soccer game: implications for sprint performance. *Med Sci Sports Exerc.* 2006;38(6): 1165-1174.
- 88 Kuipers H, Rietjens G, Verstappen F, Schoenmakers H, Hofman G. Effects of stage duration in incremental running tests on physiological variables, *Int J Sp Med,* 2003;24(7):486-91.

- 89 Lane AM, Lovejoy DJ. The effects of exercise on mood changes: the moderating effect of depressed mood. *J Sports Med Phys Fit.* 2001;41(4):539-45.
- 90 Laukkanen RMT, Virtanen P. Heart rate monitors - State of the art. *J Sports Sci.* 1998;16(S): S3-S7.
- 91 Laurent CM, Green JM, Bishop PA, Sjökvist J, Schumacker RE, Richardson MT, Curtner-Smith M. Effect of gender on fatigue and recovery following maximal intensity repeated sprint performance. *J Sports Med Phys Fitness.* 2010;50(3):243-53.
- 92 Le Bris S, Ledermann B, Candau R, Davy JM, Messner-Pellenc P, Le Gallais D. Applying a systems model of training to a patient with coronary artery disease. *Med Sci Sports Exerc.* 2004;36(6):942-8.
- 93 Lounana J, Champion F, Noakes TD, Medelli J. Relationship between %HRmax, %HR reserve, %VO2max, and %VO2 reserve in elite cyclists. *Med Sci Sports Exerc.* 2007;39(2):350-7.
- 94 Lucia A, Hoyos J, Carvajal A, Chicharro JL. Heart rate response to professional road cycling: The Tour de France. *Int J Sports Med.* 1999;20:167-72.
- 95 Lucía A, Hoyos J, Pérez M, Chicharro JL. Heart rate and performance parameters in elite cyclists: a longitudinal study. *Med Sci Sports Exerc.* 2000;32(10):1777-82.
- 96 Lucia A, Hoyos J, Santalla A, Earnest C, Chicharro JL. Tour de France versus Vuelta a España: Which is harder? *Med Sci Sports Exerc.* 2003;35(5):872-8.
- 97 Macfarlane DJ, Fogarty BA, Hopkins WC. The accuracy and variability of commercially available heart rate monitors. *NZ J Sports Med.* 1989;17(4):51-3.
- 98 Manzi V, Castagna C, Padua E, Lombardo M, D'Ottavio S, Massaro M, Volterrani M, Iellamo F. Dose-response relationship of autonomic nervous system responses to individualized training impulse in marathon runners. *Am J Physiol Heart Circ Physiol.* 2009;296(6):733-40.
- 99 Manzi V, Iellamo F, Impellizzeri F, D'Ottavio S, Castagna C. Relation between individualized training impulses and performance in distance runners. *Med Sci Sports Exerc.* 2009;41(11):2090-6.
- 100 Manzi V, D'Ottavio S, Impellizzeri FM, Chaouachi A, Chamari K, Castagna C. Profile of weekly training load in elite male professional basketball players. *J Strength Cond Res.* 2010;24(5):1399-406.
- 101 Mazzeo RA, Cavanagh P, Evans WJ, Fiatarone M, Hagberg J, McAuley E, Startzell J. Exercise and Physical Activity for Older. *Med Sci Sports Exer,* 1998;30(6): 992-1008.
- 102 McGee DS, Jesse TC, Stone MG, Blessing D. Leg and hip endurance adaptations to three different weight-training programs. *J Appl Sport Sci Res* 1992;6(2):92-5.
- 103 McLean SR, Norris SR, Smith DJ. Comparison of the Lactate Pro and the YSI 1500 Sport Blood Lactate Analyzers. *Int J Appl Sp Sci.* 2004;16(2):22-30.
- 104 McTiernan A, Kooperberg C, White E, Wilcox S, Coates R, Adams-Campbell LL, Woods N, Ockene J. Women's Health Initiative Cohort Study. Recreational physical activity and the risk of breast cancer in postmenopausal women: the Women's Health Initiative Cohort Study. *JAMA.* 2003;290(10):1331-6.
- 105 Medbø JI, Mamen A, Holt Olsen O, Evertsen F. Examination of four different instruments for measuring blood lactate concentration. *Scand J Clin Lab Invest.* 2000;60(5):367-80.

- 106 Miller TA, Thierry-Aguilera R, Congleton JJ, Amendola AA, Clark MJ, Crouse SF, Martin SM, Jenkins OC. Seasonal changes in VO₂max among Division 1A collegiate women soccer players. *J Strength Cond Res.* 2007;21(1):48-51.
- 107 Millet GP, Candau RB, Barbier B, Busso T, Rouillon JD, Chatard JC. Modelling the transfers of training effects on performance in elite triathletes. *Int J Sports Med.* 2002;23:55-63.
- 108 Millet GP, Gros Lambert A, Barbier B, Rouillon JD, Candau RB. Modelling the relationships between training, anxiety, and fatigue in elite athletes. *Int J Sports Med.* 2005;26:492-8.
- 109 Mohr M, Krstrup P, Andersson H, Kirkendal D, Bangsbo J. Match activities of elite women soccer players at different performance levels. *J Strength Cond Res.* 2008;22(2):341-349.
- 110 Morgan, WP. Anxiety reduction following acute physical activity. *Psychiatric Annals.* 1979;9(3):36-45.
- 111 Morgan WP, Brown DR, Raglin JS, O'Connor PJ, Ellickson KA. Psychological monitoring of overtraining and staleness. *Br J Sports Med.* 1987;21(3):107-14.
- 112 Morgan WP, Goldston SE, editors. *Exercise and Mental Health.* Washington DC, Hemisphere. 1987.
- 113 Morgan WP, O'Connor PJ. Exercise and mental health. In Dishman R, editor, *Exercise adherence: Its impact on public health.* Champaign: Human Kinetics; 1988. p. 155-200.
- 114 Morgan WP, Roberts JA, Brand FR, Feinerman AD. Psychological effect of chronic physical activity. *Med Sci Sports.* 1970;2(4):213-7.
- 115 Morton RH, Fitz-Clarke JR, Banister EW. Modeling human performance in running. *J Appl Physiol.* 1990;69(3):1171-7.
- 116 Mujika I, Busso T, Lacoste L, Barale F, Geysant A, Chatard J-C. Modeled responses to training and taper in competitive swimmers. *Med Sci Sports Exerc.* 1996;28(2):251-258.
- 117 Noble BJ, Borg GA, Jacobs I, Ceci R, Kaiser P. A category-ratio perceived exertion scale: relationship to blood and muscle lactates and heart rate. *Med Sci Sports Exerc.* 1983;15(6):523-8.
- 118 Padilla S, Mujika I, Orbañanos J, Angulo F. Exercise intensity during competition time trials in professional road cycling. *Med Sci Sports Exerc.* 2000;32(4):850-6.
- 119 Padilla S, Mujika I, Orbañanos J, Santisteban J, Angulo F, José Goiriena J. Exercise intensity and load during mass-start stage races in professional road cycling. *Med Sci Sports Exerc.* 2001;33(5):796-802.
- 120 Padilla S, Mujika I, Santisteban J, Impellizzeri FM, Goiriena JJ. Exercise intensity and load during uphill cycling in professional 3-week races. *Eur J Appl Physiol.* 2008;102(4):431-8.
- 121 Pate RR, Pratt M, Blair SN, Haskell WL, Macera CA, Bouchard C, Buchner D, Ettinger W, Heath GW, King AC, Kriska A, Leon AS, Marcus BH, Morris J, Paffenbarger RS, Patrick K, Pollock ML, Rippe JM, Sallis J, Wilmore JH. Physical activity and public health: a recommendation from the Centers for Disease Control and Prevention and American College of Sports Medicine. *JAMA.* 1995; 273(5):402-7.

- 122 Pyne DB, Boston T, Martin DT, Logan A. Evaluation of the Lactate Pro blood lactate analyzer. *Eur J Appl Physiol*. 2000;82:112-6.
- 123 Raglin JS, Morgan WP. Influence of exercise and quiet rest on state anxiety and blood pressure. *Med Sci Sports Exerc*. 1987;19(5):456-63.
- 124 Raglin JS. Exercise and mental health. Beneficial and detrimental effects. *Sports Med*. 1990;9(6):323-9.
- 125 Raglin JS, Morgan WP, Luchsinger AE. Mood and self-motivation in successful and unsuccessful female rowers. *Med Sci Sports Exerc*. 1990;22(6):849-53.
- 126 Richardson SO, Andersen MB, Morris T. Overtraining athletes: Personal journeys in sport. Champaign: Human Kinetics; 2008. 224 p.
- 127 Robergs RA & R Landwehr. The surprising history of the "HRmax = 220 - Age" equation. *JEPonline*. 2002;5(2). Downloaded April 7, 2011 from <http://faculty.css.edu/tboone2/asep/Robergs2.pdf> and <http://faculty.css.edu/tboone2/asep/Robergs.doc>.
- 128 Rodríguez-Marroyo JA, García-López J, Juneau CE, Villa JG. Workload demands in professional multi-stage cycling races of varying duration. *Br J Sports Med*. 2009;43(3):180-5.
- 129 Rognmo O, Hetland E, Helgerud J, Hoff J, Slordahl SA. High intensity aerobic interval exercise is superior to moderate intensity exercise for increasing aerobic capacity in patients with coronary artery disease. *Eur J Cardiovasc Preven Rehab*. 2004;11(3):216-22.
- 130 Scheuermann BW, Kowalchuk JM. Breathing Patterns during Slow and Fast Ramp Exercise in Man. *Experi Physiol*. 1999;84:109-120.
- 131 Seaward BL, Sleamaker RH, McAuliffe T, Clapp JF 3rd. The precision and accuracy of a portable heart rate monitor. *Biomed Instrum Technol*. 1990;24(1):37-41.
- 132 Selye H. The Physiology and Pathology of Exposure to Stress: A treatise based on the concepts of the General-Adaptation-Syndrome and the Disease of Adaptation. Montreal: Acta, Inc. 1950. 230 p.
- 133 Selye, H. The General-Adaptation-Syndrome and the diseases of adaptation. *Canadian Nurse*, 1952;48(1):14-6.
- 134 Selye, H. *The Stress of Life*. New York: McGraw-Hill Companies; 1978. 516 p.
- 135 Selye, H. *The Stress of Life*. Revised edition. New York: McGraw-Hill Companies; 1984. 515p.
- 136 Shephard RJ, Baldy GJ. Exercise as cardiovascular therapy. *Circulation*. 1999;99:963-72.
- 137 Stagno KM, Thatcher R, van Someren KA. A modified TRIMP to quantify the in-season training load of team sport players. *J Sports Sci*. 2007;25(6):629-634.
- 138 Steinacker JM, Lehmann M. Clinical findings and mechanisms of stress and recovery in athletes. In Kellmann M, editor. *Enhancing recovery: preventing underperformance in athletes*. Champaign: Human Kinetics; 2002. p. 103-18.
- 139 Stølen T, Chamari K, Castagna C, Wisløff U. Physiology of soccer: an update. *Sports Med*, 2005;35(6):501-36.
- 140 Strøyer J, Hansen L, Klausen K. Physiological profile and activity pattern of young soccer players during match play. *Med Sci Sports Exerc*. 2004; 36(1): 168-74.

- 141 Strohle A. Physical activity, exercise, depression and anxiety disorders. *J Neural Transm.* 2009;116(6):777-84
- 142 Swain DP, Leutholtz BC, King ME, Haas LA, Branch JD. Relationship between % heart rate reserve and % VO₂ reserve in treadmill exercise. *Med Sci Sports Exerc.* 1998;30(2):318-21.
- 143 Sweet TW, Foster C, McGuigan MR, Brice G, Quantitation of resistance training using the session rating of perceived exertion method. *J Strength Cond Res.* 2004;18(4):796–802.
- 144 Takken T, Ribbink A, Heneweer H, Moolenaar H, Wittink H. Workload demand in police officers during mountain bike patrols. *Ergonomics.* 2009;52(2):245-50.
- 145 Tanner RK, Fuller KL, Ross MLR. Evaluation of three portable blood lactate analyzers: Lactate Pro, Lactate Scout and Lactate Plus. *Eur J Appl Physiol.* 2010;109:551-9.
- 146 Thivierge M, Leger L. Critical review of heart rate monitors. *CAHPER J.* 1989;55(3):26-31.
- 147 Thomas L, Mujika I, Busso T. A model study of optimal training reduction during pre-event taper in elite swimmers. *J Sports Sci.* 2008;26(6):643-52.
- 148 U. S. Department of Health and Human Services. *Physical activity and health: A report of the Surgeon General—At a glance.* 1996. Atlanta, GA: U.S. Department of Health and Human Services, Centers for Disease Control and Prevention, National Center for Chronic Disease Prevention and Health Promotion: 1996. 4 p. Available from: <http://www.cdc.gov/nccdphp/sgr/pdf/sgraag.pdf>.
- 149 Wajciechowski JA, Gayle RC, Andrews RL, Dintiman GB. The accuracy of radio telemetry heart rate monitoring during exercise. *Clinical Kinesiology.* 1991;45:9-12.
- 150 Wallace LK, Slattery KM, Coutts AJ. The ecological validity and application of the session-RPE method for quantifying training loads in swimming. *J Strength Cond Res.* 2009;23(1):33-8.
- 151 Warburton DE, Katzmarzyk PT, Rhodes RE, Shephard RJ. Evidence-informed physical activity guidelines for Canadian adults. *Can J Public Health.* 2007;98(S2):S16-68.
- 152 Weil MH, Leavy JA, Rackow EC, Halfman CJ, Bruno SJ. Validation of a semi-automated technique for measuring lactate in whole blood. *Clinical Chemistry.* 1986;32:2175-7.
- 153 Wilson, II RW, Goepfinger TS, Wade BA, Snyder AC. Assessment of Multiple Physiological Variables for Use in the Quantification of Physiological Load. 2012.
- 154 Wilson II RW, Reynolds K, Snyder AC. Use of a Physiological Monitoring System to Determine Ventilatory Threshold. *J Strength Cond Res* 2011;25(S1): S113.
- 155 Wilson RW, Snyder AC, Pire RJ. Heart rates of hockey players during on-ice practices. *J Strength Cond Res.* 2007;21(4):e1-e41.
- 156 Wilson, II RW, Snyder AC. Validation of Model for Determination of the Physiological Load of Collegiate Soccer Players. 2012.
- 157 Wood RE, Hayter S, Rowbottom D, Stewart I. Applying a mathematical model to training adaptation in a distance runner. *Eur J Appl Physiol.* 2005;94(3):310-6.

- 158 World Health Organization. *Global Recommendations on Physical activity for Health. (2010)*. Geneva, Switzerland: World Health Organization; 2010. 60 p. Available from http://www.who.int/dietphysicalactivity/factsheet_recommendations/en/ on.

**Appendix A: Institutional Review Board at UW–M Approval
Documents - Protocol 07_02_172 (2010)**



Department of University Safety & Assurances

Benjamin J. Kennedy, MA
 IRB Manager
 Institutional Review Board
 Engelmann 270
 P. O. Box 413
 Milwaukee, WI
 53201-0413
 (414) 229-3182 phone
 (414) 229-6729 fax
<http://www.irb.uwm.edu>
kennedbi@uwm.edu

Continuing Review - Notice of IRB Expedited Approval

Date: December 11, 2009

To: Ann Snyder, PhD
Dept: Human Movement Sciences

Cc: -

IRB#: 07.02.172

Title: Heart Rate Responses During Team and Individual Exercises

After review of your research protocol by the University of Wisconsin – Milwaukee Institutional Review Board, your protocol has received continuing approval as minimal risk Expedited under **category 4 & 7** as governed by 45 CFR 46.110.

This protocol has been approved on **December 11, 2009** for one year. IRB approval will expire on **December 10, 2010**. If you plan to continue any research related activities (e.g., enrollment of subjects, study interventions, data analysis, etc.) past the date of IRB expiration, a Continuation for IRB Approval must be filed by the submission deadline. If the study is closed or completed before the IRB expiration date, please notify the IRB by completing and submitting the Continuing Review form found on the IRB website.

Unless specifically where the change is necessary to eliminate apparent immediate hazards to the subjects, any proposed changes to the protocol must be reviewed by the IRB before implementation. It is the principal investigator's responsibility to adhere to the policies and guidelines set forth by the UWM IRB and maintain proper documentation of its records and promptly report to the IRB any adverse events which require reporting.

It is the principal investigator's responsibility to adhere to UWM and UW System Policies, and any applicable state and federal laws governing activities the principal investigator may seek to employ (e.g., [FERPA](#), [Radiation Safety](#), [UWM Data Security](#), [UW System policy on Prizes, Awards and Gifts](#), State gaming laws, etc.) which are independent of IRB review/approval.

Contact the IRB office if you have any further questions. Thank you for your cooperation and best wishes for a successful project.

Respectfully,

Redacted for privacy

Benjamin J. Kennedy
 IRB Manager
 CC: Study File



Department of University Safety & Assurances

Benjamin J. Kennedy, MA
 IRB Manager
 Institutional Review Board
 Engelmann 270
 P. O. Box 413
 Milwaukee, WI
 53201-0413
 (414) 229-3182 phone
 (414) 229-6729 fax
<http://www.irb.uwm.edu>
kenmedb1@uwm.edu

Continuing Review - Notice of IRB Expedited Approval

Date: March 18, 2011

To: Ann Snyder, PhD
Dept: Human Movement Sciences

Cc: -

IRB#: 07.02.172

Title: Heart Rate Responses During Team and Individual Exercises

After review of your research protocol by the University of Wisconsin – Milwaukee Institutional Review Board, your protocol has received continuing approval as minimal risk Expedited under **category 4 & 7** as governed by 45 CFR 46.110.

This protocol has been approved on **March 18, 2011** for one year. IRB approval will expire on **March 17, 2012**. If you plan to continue any research related activities (e.g., enrollment of subjects, study interventions, data analysis, etc.) past the date of IRB expiration, a Continuation for IRB Approval must be filed by the submission deadline. If the study is closed or completed before the IRB expiration date, please notify the IRB by completing and submitting the Continuing Review form found on the IRB website.

Unless specifically where the change is necessary to eliminate apparent immediate hazards to the subjects, any proposed changes to the protocol must be reviewed by the IRB before implementation. It is the principal investigator's responsibility to adhere to the policies and guidelines set forth by the UWM IRB and maintain proper documentation of its records and promptly report to the IRB any adverse events which require reporting.

It is the principal investigator's responsibility to adhere to UWM and UW System Policies, and any applicable state and federal laws governing activities the principal investigator may seek to employ (e.g., [FERPA](#), [Radiation Safety](#), [UWM Data Security](#), [UW System policy on Prizes, Awards and Gifts](#), State gaming laws, etc.) which are independent of IRB review/approval.

Contact the IRB office if you have any further questions. Thank you for your cooperation and best wishes for a successful project.

Respectfully,

Redacted for privacy

Benjamin J. Kennedy
 IRB Manager
 CC: Study File



*Benjamin J. Kennedy, MA
 IRB Manager
 Institutional Review Board
 Engelmann 270
 P. O. Box 413
 Milwaukee, WI
 53201-0413
 (414) 229-3182 phone
 (414) 229-6729 fax
<http://www.irb.uwm.edu>
kemedbj@uwm.edu*

Modification/Amendment - IRB Expedited Approval

Date: July 21, 2011

To: Barbara Meyer, PhD
Dept: Human Movement Sciences

Cc: Rob Wilson, MS

IRB#: 07.02.172

Title: Heart Rate Responses During Team and Individual Exercises

After review of your research protocol by the University of Wisconsin – Milwaukee Institutional Review Board, your protocol has received modification/amendment approval for:

1. Revise study procedures for athletes to add submaximal test at the beginning of the season, maximal test at the middle of the season, and both a submaximal and maximal test at the end of the season;
2. Revise study subjects to include coaches; request to obtain verbal consent from coaches; the coaches will rate the intended/ expected intensity level of the practices and competitions using a modified version of the Borg Criterion Referenced 10-point (CR-10) Rating of Perceived Exertion scale. After practices and competitions, the coach will be asked to provide their rating of perceived exertion for the players for the event;
3. Revise study procedures for athletes to provide their rating of perceived exertion for the event using the modified CR-10 RPE scale (the same scale used in the laboratory testing sessions);
4. Revise study to collect information related to why players did not participate in practices and competitions;
5. Addition of a chest-worn physiological monitor that collects multiple variables (heart rate, movement intensity, breathing rate, skin temperature, peak acceleration, and body position) will be worn during testing and selected practice and competitions;
6. Updated Consent Document; and
7. Updated Protocol Summary Form.

IRB approval will expire on **03/17/2012**. If you plan to continue any research related activities (e.g., enrollment of subjects, study interventions, data analysis, etc.) past the date of IRB expiration, a Continuation for IRB Approval must be filed by the submission deadline. If the study is closed or completed before the IRB expiration date, please notify the IRB by completing and submitting the Continuing Review form found on the IRB website.

Unless specifically where the change is necessary to eliminate apparent immediate hazards to the subjects, any proposed changes to the protocol must be reviewed by the IRB before implementation. It is the principal investigator's responsibility to adhere to the policies and

guidelines set forth by the UWM IRB and maintain proper documentation of its records and promptly report to the IRB any adverse events which require reporting.

It is the principal investigator's responsibility to adhere to UWM and UW System Policies, and any applicable state and federal laws governing activities the principal investigator may seek to employ (e.g., [FERPA](#), [Radiation Safety](#), [UWM Data Security](#), [UW System policy on Prizes, Awards and Gifts](#), State gaming laws, etc.) which are independent of IRB review/approval.

Contact the IRB office if you have any further questions. Thank you for your cooperation and best wishes for a successful project.

Respectfully,

Redacted for privacy

Benjamin J. Kennedy
IRB Manager
CC: Study File



Melissa Spadanuda
 IRB Administrator
 Institutional Review Board
 Engelmann 270
 P. O. Box 413
 Milwaukee, WI 53201-0413
 (414) 229-3173 phone
 (414) 229-6729 fax

Continuing Review - Notice of IRB Expedited Approval

<http://www.irb.uwm.edu>
spadanud@uwm.edu

Date: March 19, 2012

To: Barbara Meyer, PhD
Dept: Human Movement Sciences

Cc: Rob Wilson, MS

IRB#: 07.02.172

Title: Heart Rate Responses During Team and Individual Exercises

After review of your research protocol by the University of Wisconsin – Milwaukee Institutional Review Board, your protocol has received continuing approval as minimal risk Expedited under **category 4 and 7** as governed by 45 CFR 46.110.

This protocol has been approved on **March 19, 2012** for one year. IRB approval will expire on **March 18, 2013**. If you plan to continue any research related activities (e.g., enrollment of subjects, study interventions, data analysis, etc.) past the date of IRB expiration, a Continuation for IRB Approval must be filed by the submission deadline. If the study is closed or completed before the IRB expiration date, please notify the IRB by completing and submitting the Continuing Review form found on the IRB website.

Unless specifically where the change is necessary to eliminate apparent immediate hazards to the subjects, any proposed changes to the protocol must be reviewed by the Institutional Review Board before implementation.

Please note that it is the principal investigator's responsibility to adhere to the policies and guidelines set forth by the University of Wisconsin – Milwaukee and its Institutional Review Board. It is the principal investigator's responsibility to maintain proper documentation of its records and promptly report to the Institutional Review Board any adverse events which require reporting.

Contact the IRB office if you have any further questions. Thank you for your cooperation and best wishes for a successful project

Respectfully

Redacted for privacy

Melissa C. Spadanuda
 IRB Administrator

Appendix B: Informed Consent Document and Health History
Questionnaire for Protocol 07_02_172 (2010)

Informed Consent
 UW - Milwaukee
 Date of last revision 2010-10-07

IRB Protocol Number: 07.02.172

IRB Approval date: 01-08-2007

UNIVERSITY OF WISCONSIN – MILWAUKEE CONSENT TO PARTICIPATE IN RESEARCH

1. GENERAL INFORMATION

Study title: Heart Rate Responses During Team and Individual Exercises

Person in Charge of Study: Ann C. Snyder, Ph.D.

I am a professor in the Department of Human Movement Sciences at the University of Wisconsin – Milwaukee. I am conducting a study on heart rate responses during team and individual exercises. I will be collecting these heart rates during both practice sessions and competitions.

2. STUDY DESCRIPTION

Study description:

The purpose of this study is to monitor the heart rate of athletes performing team and individual exercises during both practices and competitions. Energy expenditure during exercise can be estimated by measuring heart rate. While the accurate measurement of heart rate is now very simple to do noninvasively by having the athlete wear a one inch wide strap around their chest, measurement of heart rate during team events, such as soccer, basketball, crew, hockey, dancing, running, etc. have not been possible until now (do to the fact that multiple straps would cause interference with data collection). New technology has now made the collection of heart rate during team activities possible. Therefore, you are being asked to be one of about 250 athletes in this study so that we can monitor your heart rate during your practice and competition. We will be monitoring you up to 10 times in total. Your participation in this research study is completely voluntary and you do not have to participate in the study if you do not wish to. Further, you can withdraw from the study at any time that you wish to. Data collection will be dependent on where the practice and competitions take place and we will always come to you for this data collection. In some cases you might be required to wear a small transmitter on the chest strap. Both the strap and the transmitter can be worn under uniforms and the technology has been used for many years by athletes of individual sports (running, cycling, etc.) and no complications have occurred do to the use of this equipment.

Version: ____

This Consent Form has been approved by the IRB for a one year period.

Page 1 of 5

Informed Consent
 UW - Milwaukee
 Date of last revision 2010-10-07

IRB Protocol Number: 07.02.172

IRB Approval date: 01-08-2007

3. STUDY PROCEDURES

What will I be asked to do if I participate in the study?

If you agree to participate you will be asked to wear a heart rate strap while you are practicing and/or competing in a team sport. You may also undergo a maximal exercise test on a treadmill or bicycle to help us understand better the information that we obtain during your practices or competitions. During the maximal test, you will exercise until you can no longer continue. During the maximal exercise you will breathe through a facemask so that your energy expenditure may be determined. Your heart rate, determined by a heart rate monitor, will be monitored throughout the test. Your fingertip will be pricked with a lancet (a needle type instrument) and a small amount of blood (just several drops) will be squeezed from your fingertip one or two minutes after the maximal test is done. This blood will be used to see how much lactate is in your blood. You will also have a small pad placed on your thigh that will shine light into your muscles, to determine how much oxygen is being used by your thigh muscles. You will also be asked how hard you feel that you are exercising regularly throughout the test. You may also undergo other physiological tests (e.g., the Wingate Anaerobic Test on a cycle, the Bosco Jump Test, the Repeated Anaerobic Sprint Test on a hard surface (e.g., track or gymnasium floor), grass, a motorized treadmill and/or a non-motorized treadmill, etc.) related to the sport in which you compete. You will be given enough time between the tests for proper and sufficient for recovery. You may also be asked to keep a daily log to track activities that can affect performance or complete a questionnaire to help us understand your sport participation history.

4. RISKS & MINIMIZING RISKS

What risks will I face by participating in this study?

During the practice session or competition, the risk to you is no greater than that which would have occurred if you had just performed the practice or competition.

If you perform a maximal exercise test, at the maximal exercise intensity you will be fatigued and short of breath and you may be sweating. Maximal exercise will increase the rate that your heart beats and in some individuals that will feel like their heart is pounding. You need to know that the response of the cardiovascular system cannot be predicted with complete accuracy. In rare instances a "heart attack" or "cardiac arrest" may occur. Individuals trained in cardiopulmonary resuscitation (CPR) will be on hand during all testing and the test will be stopped if you feel chest pain, dizziness, unusual or severe shortness of breath, leg pain or cramping, or that you simply want to stop at any point. You providing accurate answers to the Medical History/Physical Activity Questionnaire will reduce the risk of these events occurring.

Your data identified by name will be given to your coach, to enhance your ability. However, the information from the Health Questionnaire will not be given to your coach.

Version: ____

Page 2 of 5

This Consent Form has been approved by the IRB for a one year period.

Informed Consent
UW - Milwaukee
 Date of last revision 2010-10-07

IRB Protocol Number: 07.02.172

IRB Approval date: 01-08-2007

As for research purposes, your data will be coded with a distinct coding and no names will be associated with your collected data. The data will only be identified by sport and position played, but not by the individual athlete. Thus, there will be a link between subject/distinct coding and data, however the data and the your information will be kept in different locked locations in the Human Performance Laboratory of UWM. The data will be kept for 10 years. Any publication or presentation of the data will not identify you as a subject.

5. BENEFITS

Will I receive any benefit from my participation in this study?

You should benefit from this research by seeing exactly how hard you were working during the practice and competition and by having the coach modify the practice sessions due to this information to maximize your exercise performance.

Are subjects paid or given anything for being in the study?

You will not be paid for taking part in this research study.

6. STUDY COSTS

Will I be charged anything for participating in this study?

You will not be responsible for any of the costs from taking part in this research study.

7. CONFIDENTIALITY

What happens to the information collected?

All information collected about you during the course of this study will be kept confidential to the extent permitted by law. We may decide to present what we find to others, or publish our results in scientific journals or at scientific conferences. Only the PI and students working in the laboratory, along with your coaches will have access to the information. However, the Institutional Review Board at UW-Milwaukee or appropriate federal agencies like the Office for Human Research Protections may review your records.

8. ALTERNATIVES

Are there alternatives to participating in the study?

There are no known alternatives available to you other than not taking part in this study.

Version: ____

This Consent Form has been approved by the IRB for a one year period.

Page 3 of 5

Informed Consent
 UW - Milwaukee
 Date of last revision 2010-10-07

IRB Protocol Number: 07.02.172

IRB Approval date: 01-08-2007

9. VOLUNTARY PARTICIPATION & WITHDRAWAL

What happens if I decide not to be in this study?

Your participation in this study is entirely voluntary. You may choose not to take part in this study, or if you decide to take part, you can change your mind later and withdraw from the study. You are free to not answer any questions or withdraw at any time. Your decision will not change any present or future relationships with the University of Wisconsin Milwaukee. The investigator may stop your participation in this study if she feels it is necessary to do so. If you withdraw from the study, the information collected on you to that point will still be used in this research study.

10. QUESTIONS

Who do I contact for questions about this study?

For more information about the study or the study procedures or treatments, or to withdraw from the study, contact:

Ann C. Snyder, Ph.D.
 Human Performance Laboratory
 Department of Human Movement Sciences
 P.O. Box 413
 Milwaukee, WI 53201
 414-229-5127

Who do I contact for questions about my rights or complaints towards my treatment as a research subject?

The Institutional Review Board may ask your name, but all complaints are kept in confidence.

Institutional Review Board
 Human Research Protection Program
 Department of University Safety and Assurances
 University of Wisconsin – Milwaukee
 P.O. Box 413
 Milwaukee, WI 53201
 (414) 229-3173

Version: ____

This Consent Form has been approved by the IRB for a one year period.

Page 4 of 5

Informed Consent
 UW - Milwaukee
 Date of last revision 2010-10-07

IRB Protocol Number: 07.02.172

IRB Approval date: 01-08-2007

11. SIGNATURES

Research Subject's Consent to Participate in Research:

To voluntarily agree to take part in this study, you must sign on the line below. If you choose to take part in this study, you may withdraw at any time. You are not giving up any of your legal rights by signing this form. Your signature below indicates that you have read or had read to you this entire consent form, including the risks and benefits, and have had all of your questions answered, and that you are 18 years of age or older.

 Printed Name of Subject/ Legally Authorized Representative

 Signature of Subject/Legally Authorized Representative

 Date

It is okay to photograph me while I am in this study and to use my photograph in the presentation of the research:

Please initial: _____ Yes _____ No

Complete this section if the subject is a minor:

 Printed Name of Subject

 Signature of Subject

 Date

 Printed Name of Subject's Parent/Legally Authorized Representative

 Signature of Subject's Parent/Legally Authorized Representative

 Date

It is okay to photograph my child while they are in this study:

Please initial: _____ Yes _____ No

Principal Investigator (or Designee)

I have given this research subject information on the study that is accurate and sufficient for the subject to fully understand the nature, risks and benefits of the study.

 Printed Name of Person Obtaining Consent

 Role on Study

 Signature of Person Obtaining Consent

 Date

Version: _____

This Consent Form has been approved by the IRB for a one year period.

Page 5 of 5

HEALTH HISTORY/PHYSICAL ACTIVITY QUESTIONNAIRE

Name	Date	
Address		
City	State	Zip Code
Telephone (Home)	Work	
Date of Birth	Height (in)	Height (cm)
Gender	Weight (lb)	Weight (kg)

Although participation in exercise is relatively safe for most apparently healthy individuals, the reaction of the cardiovascular system to increased levels of physical activity cannot always be totally predicted. Consequently, there is a small but real risk of certain changes occurring during exercise participation. Some of these changes may include abnormal blood pressure, irregular heart rhythm, fainting, and in rare instances, a heart attack or cardiac arrest. Therefore, it is imperative that you provide honest answers to this questionnaire. Exercise may be contraindicated under some of the conditions listed below; others may simply require special consideration. If any of the conditions apply, consult your physician before you participate in an exercise program.

A. Have you ever had or do you now have any of the following conditions:

- 1. Heart failure
- 2. Coronary artery disease
- 3. Congestive heart failure
- 4. Elevated blood lipids (cholesterol and triglycerides)
- 5. Chest pain at rest or during exertion
- 6. Shortness of breath
- 7. An abnormal resting or stress electrocardiogram
- 8. Uneven, irregular, or skipped heartbeats (including racing or fluttering heart)
- 9. A blood clot
- 10. A clot or irritation of the wall of the vein
- 11. Rheumatic heart fever
- 12. Elevated blood pressure
- 13. A stroke
- 14. Diabetes
- 15. Cancer
- 16. A hernia
- 17. Any known bleeding disorders
- 18. Any other heart problem that makes exercise unsafe.

B. Do you suffer from any of the following conditions:

- 1. Arthritis, rheumatism, or gout
- 2. Chronic low back pain
- 3. Any other joint, bone, or muscle problems
- 4. Any respiratory or pulmonary problems
- 5. Obesity (more than 30% overweight)
- 6. Anorexia
- 7. Bulimia
- 8. Mononucleosis

- C. Immediate Family History (mother, father, maternal grandmother or grandfather, paternal grandmother or grandfather, brothers, sisters, children).

Have any of the above had:

- ___ 1. Stroke
 ___ 2. Heart Disease
 ___ 3. Cancer
 ___ 4. Tuberculosis
 ___ 5. Kidney Disease
 ___ 6. High Blood Pressure
 ___ 7. Diabetes
 ___ 8. Migraines

- D. Do any of the following conditions apply?

1. Do you currently smoke cigarettes? _____

If yes, how many packs per day? _____

If no, have you ever smoked cigarettes? _____

For how many years? _____

2. Do you currently drink coffee and/or tea? _____

If yes, what is your weekly consumption? _____

3. Do you take any medications (both prescribed and over-the-counter) or nutritional supplements? _____

Please list all medications and supplements:

Medication/Supplement	Purpose
_____	_____
_____	_____
_____	_____

- E. Have you ever had surgery? _____
If yes, please specify:

_____	_____
	Date
_____	_____
	Date
_____	_____
	Date

- F. Physical Activity:

Do you engage in regular physical activity? _____

If no, when did you last participate in a regular exercise program?

If yes, please specify below:

Activity	# Sessions per week	Amount of time per session
_____	_____	_____
_____	_____	_____
_____	_____	_____
_____	_____	_____
_____	_____	_____

Appendix C: Informed Consent Document and Health History

Questionnaire for Protocol 07_02_172 (2011)

Informed Consent
 UW - Milwaukee
 Date of last revision 2011-07-18

IRB Protocol Number: 07.02.172

IRB Approval date: 07/21/2011

UNIVERSITY OF WISCONSIN – MILWAUKEE CONSENT TO PARTICIPATE IN RESEARCH

1. GENERAL INFORMATION

Study title: Heart Rate Responses During Team and Individual Exercises

Person in Charge of Study: Barbara B. Meyer, Ph.D.

I am a professor in the Department of Human Movement Sciences at the University of Wisconsin – Milwaukee. I am conducting a study on heart rate responses during team and individual exercises. I will be collecting these heart rates during both practice sessions and competitions.

2. STUDY DESCRIPTION

Study description:

The purpose of this study is to monitor athletes performing team and individual exercises during both practices and competitions using objective and subjective information. Energy expenditure during exercise can be estimated by measuring heart rate. While the accurate measurement of heart rate is now very simple to do noninvasively by having the athlete wear a one inch wide strap around their chest, measurement of heart rate during team events, such as soccer, basketball, crew, hockey, dancing, running, etc. has not been possible until now (do to the fact that multiple straps would cause interference with data collection). Technological advances has now made the collection of heart rate and other variables (such as breathing rate, movement intensity, skin temperature, peak acceleration, body position) during team activities possible. Therefore, you are being asked to be one of about 250 athletes in this study so that we can monitor you during your practices and competitions. The duration of the monitoring may be daily or intermittently for the length of your season. Your participation in this research study is completely voluntary and you do not have to participate in the study if you do not wish to. Further, you can withdraw from the study at any time that you wish to. Data collection will depend on where the practice and competitions take place and we will always come to you for this data collection. In some cases you might be required to wear a monitor with a transmitter on the chest strap. Both the strap and the transmitter can be worn under uniforms and the technology has been used for many years by athletes of individual sports (running, cycling, etc.) and no complications have occurred do to the use of this equipment.

Version: ____

This Consent Form has been approved by the IRB for a one year period.

Page 1 of 5

Informed Consent
 UW - Milwaukee
 Date of last revision 2011-07-18

IRB Protocol Number: 07.02.172

IRB Approval date: 07/21/2011

3. STUDY PROCEDURES

What will I be asked to do if I participate in the study?

If you agree to participate you will be asked to wear a monitor strap on your chest while you are practicing and/or competing in a team sport. You may also undergo maximal effort exercise tests on a treadmill or bicycle to help us understand better the information that we obtain during your practices or competitions. The maximal test will last until you can no longer continue. During the maximal exercise you will breathe through a facemask so that your energy expenditure may be determined. Your physiological responses, determined by the chest-worn monitor, will be monitored throughout the test. Your fingertip will be pricked with a lancet (a needle type instrument) and a small amount of blood (just several drops) will be squeezed from your fingertip one or two minutes after the maximal effort test is over. This blood will be used to see how much lactate is in your blood. You may also have a small pad placed on your thigh that will shine light into your muscles, to determine how much oxygen is being used by your thigh muscles. You will also be asked how hard you feel that you are exercising regularly throughout the test. You may also undergo other physiological tests (e.g., a sub-maximal Effort Test on a treadmill or cycle, the Wingate Anaerobic Test on a cycle, the Bosco Jump Test, the Repeated Anaerobic Sprint Test on a hard surface (e.g., track or gymnasium floor, grass, a motorized treadmill and/or a non-motorized treadmill, etc.) related to the sport in which you compete. You will be given enough time between the tests for proper and sufficient for recovery. You may also be asked to keep a daily log to track activities that can affect performance, complete a questionnaire to help us understand your sport participation history, provide your rating of perceived exertion for practices and competitions using the same 10-point exertion scale that was used during the testing. If you do not participate in a practice or game, we will ask for a general reason.

Your coach will also be asked to provide their expected intensity level for the practice or competition and then a post-event rating of how hard they thought the event was using the same 10-point scale as you will be using.

4. RISKS & MINIMIZING RISKS

What risks will I face by participating in this study?

During the practice session or competition, the risk to you is no greater than that which would have occurred if you had just performed the practice or competition.

If you perform a maximal exercise test, at the maximal exercise intensity you will be fatigued and short of breath and you may be sweating. Maximal exercise will increase the rate that your heart beats and in some individuals that will feel like their heart is pounding. You need to know that the response of the cardiovascular system cannot be predicted with complete accuracy. In rare instances a "heart attack" or "cardiac arrest"

Version: ____

This Consent Form has been approved by the IRB for a one year period.

Page 2 of 5

Informed Consent
 UW - Milwaukee
 Date of last revision 2011-07-18

IRB Protocol Number: 07.02.172

IRB Approval date: 07/21/2011

may occur. Individuals trained in cardiopulmonary resuscitation (CPR) will be on hand during all testing and the test will be stopped if you feel chest pain, dizziness, unusual or severe shortness of breath, leg pain or cramping, or that you simply want to stop at any point. You providing accurate answers to the Medical History/Physical Activity Questionnaire will reduce the risk of these events occurring.

Your data identified by name will be given to your coach (to track and enhance your performance) and to you. However, the information from the Health Questionnaire will not be given to your coach. As for research purposes, your data will be coded with a distinct coding and no names will be associated with your collected data. The data will only be identified by sport and position played, but not by the individual athlete. Thus, there will be a link between subject/distinct coding and data, however the data and the your information will be kept in different locked locations in the Human Performance Laboratory of UWM. The data will be kept for 10 years. Any publication or presentation of the data will not identify you as a subject.

5. BENEFITS

Will I receive any benefit from my participation in this study?

You should benefit from this research by seeing exactly how hard you were working during the practice and competition and by having the coach modify the practice sessions due to this information to maximize your exercise performance.

Are subjects paid or given anything for being in the study?

You will not be paid for taking part in this research study.

6. STUDY COSTS

Will I be charged anything for participating in this study?

You will not be responsible for any of the costs from taking part in this research study.

7. CONFIDENTIALITY

What happens to the information collected?

All information collected about you during the course of this study will be kept confidential to the extent permitted by law. We may present what we find to others, or publish our results in scientific journals or at scientific conferences. Only the PI and students working in the laboratory, along with your coaches will have access to the information. However, the Institutional Review Board at UW-Milwaukee or appropriate federal agencies like the Office for Human Research Protections may review your records.

Version: ____

This Consent Form has been approved by the IRB for a one year period.

Page 3 of 5

Informed Consent
 UW - Milwaukee
 Date of last revision 2011-07-18

IRB Protocol Number: 07.02.172
 IRB Approval date: 07/21/2011

8. ALTERNATIVES

Are there alternatives to participating in the study?

There are no known alternatives available to you other than not taking part in this study.

9. VOLUNTARY PARTICIPATION & WITHDRAWAL

What happens if I decide not to be in this study?

Your participation in this study is entirely voluntary. You may choose not to take part in this study, or if you decide to take part, you can change your mind later and withdraw from the study. You are free to not answer any questions or withdraw at any time. Your decision will not change any present or future relationships with the University of Wisconsin Milwaukee. The investigator may stop your participation in this study if she feels it is necessary to do so. If you withdraw from the study, the information collected on you to that point will still be used in this research study.

10. QUESTIONS

Who do I contact for questions about this study?

For more information about the study or the study procedures or treatments, or to withdraw from the study, contact:

Ann C. Snyder, Ph.D.
 Human Performance Laboratory
 Department of Human Movement Sciences
 P.O. Box 413
 Milwaukee, WI 53201
 414-229-5127

Who do I contact for questions about my rights or complaints towards my treatment as a research subject?

The Institutional Review Board may ask your name, but all complaints are kept in confidence.

Institutional Review Board
 Human Research Protection Program
 Department of University Safety and Assurances
 University of Wisconsin – Milwaukee
 P.O. Box 413
 Milwaukee, WI 53201
 (414) 229-3173

Version: ____

This Consent Form has been approved by the IRB for a one year period.

Page 4 of 5

Informed Consent
 UW - Milwaukee
 Date of last revision 2011-07-18

IRB Protocol Number: 07.02.172

IRB Approval date: 07/21/2011

11. SIGNATURES

Research Subject's Consent to Participate in Research:

To voluntarily agree to take part in this study, you must sign on the line below. If you choose to take part in this study, you may withdraw at any time. You are not giving up any of your legal rights by signing this form. Your signature below indicates that you have read or had read to you this entire consent form, including the risks and benefits, and have had all of your questions answered, and that you are 18 years of age or older.

 Printed Name of Subject/ Legally Authorized Representative

 Signature of Subject/Legally Authorized Representative

 Date

It is okay to photograph me while I am in this study and to use my photograph in the presentation of the research:

Please initial: _____ Yes _____ No

Complete this section if the subject is a minor:

 Printed Name of Subject

 Signature of Subject

 Date

 Printed Name of Subject's Parent/Legally Authorized Representative

 Signature of Subject's Parent/Legally Authorized Representative

 Date

It is okay to photograph my child while they are in this study:

Please initial: _____ Yes _____ No

Principal Investigator (or Designee)

I have given this research subject information on the study that is accurate and sufficient for the subject to fully understand the nature, risks and benefits of the study.

 Printed Name of Person Obtaining Consent

 Role on Study

 Signature of Person Obtaining Consent

 Date

Version: ____

This Consent Form has been approved by the IRB for a one year period.

Page 5 of 5

HEALTH HISTORY/PHYSICAL ACTIVITY QUESTIONNAIRE

Name	Date	
Address		
City	State	Zip Code
Telephone (Home)	Work	
Date of Birth	Height (in)	Height (cm)
Gender	Weight (lb)	Weight (kg)

Although participation in exercise is relatively safe for most apparently healthy individuals, the reaction of the cardiovascular system to increased levels of physical activity cannot always be totally predicted. Consequently, there is a small but real risk of certain changes occurring during exercise participation. Some of these changes may include abnormal blood pressure, irregular heart rhythm, fainting, and in rare instances, a heart attack or cardiac arrest. Therefore, it is imperative that you provide honest answers to this questionnaire. Exercise may be contraindicated under some of the conditions listed below; others may simply require special consideration. If any of the conditions apply, consult your physician before you participate in an exercise program.

A. Have you ever had or do you now have any of the following conditions:

- 1. Heart failure
- 2. Coronary artery disease
- 3. Congestive heart failure
- 4. Elevated blood lipids (cholesterol and triglycerides)
- 5. Chest pain at rest or during exertion
- 6. Shortness of breath
- 7. An abnormal resting or stress electrocardiogram
- 8. Uneven, irregular, or skipped heartbeats (including racing or fluttering heart)
- 9. A blood clot
- 10. A clot or irritation of the wall of the vein
- 11. Rheumatic heart fever
- 12. Elevated blood pressure
- 13. A stroke
- 14. Diabetes
- 15. Cancer
- 16. A hernia
- 17. Any known bleeding disorders
- 18. Any other heart problem that makes exercise unsafe.

B. Do you suffer from any of the following conditions:

- 1. Arthritis, rheumatism, or gout
- 2. Chronic low back pain
- 3. Any other joint, bone, or muscle problems
- 4. Any respiratory or pulmonary problems
- 5. Obesity (more than 30% overweight)
- 6. Anorexia
- 7. Bulimia
- 8. Mononucleosis

- C. Immediate Family History (mother, father, maternal grandmother or grandfather, paternal grandmother or grandfather, brothers, sisters, children).

Have any of the above had:

- ___ 1. Stroke
 ___ 2. Heart Disease
 ___ 3. Cancer
 ___ 4. Tuberculosis
 ___ 5. Kidney Disease
 ___ 6. High Blood Pressure
 ___ 7. Diabetes
 ___ 8. Migraines

- D. Do any of the following conditions apply?

1. Do you currently smoke cigarettes? _____

If yes, how many packs per day? _____

If no, have you ever smoked cigarettes? _____

For how many years? _____

2. Do you currently drink coffee and/or tea? _____

If yes, what is your weekly consumption? _____

3. Do you take any medications (both prescribed and over-the-counter) or nutritional supplements? _____

Please list all medications and supplements:

Medication/Supplement	Purpose
_____	_____
_____	_____
_____	_____

- E. Have you ever had surgery? _____
If yes, please specify:

_____	_____
	Date
_____	_____
	Date
_____	_____
	Date

- F. Physical Activity:

Do you engage in regular physical activity? _____

If no, when did you last participate in a regular exercise program?

If yes, please specify below:

Activity	# Sessions per week	Amount of time per session
_____	_____	_____
_____	_____	_____
_____	_____	_____
_____	_____	_____
_____	_____	_____

Appendix D: Permissions to use Copyrighted materials

Permission request granted

From : Sarah Merrill <sarahmerrill@csep.ca>
Subject : Permission request granted
To : rwwilson@uwm.edu

Wed, May 23, 2012 08:55 AM

 Diss

 1 attachment

Hi Rob,

Your request to use the CSEP item specified in your dissertation has been approved. There is a specific acknowledgement line that we ask that you use. You can find it in the 'Notes' section of the attached confirmation. There is no charge associated with this item.

Please let me know if you have any further questions,

--

Sarah Merrill
Administrative Assistant
Canadian Society for Exercise Physiology
18 Louisa St, Suite 370
Ottawa, ON K1R 6Y6
sarahmerrill@csep.ca
1-877-651-3755 ext.226



RWilson-DissertationPermission.pdf
100 KB



Canadian Society for Exercise Physiology,
#370 18 Louisa St Ottawa ON K1R 6Y6
1 877 651 3755 info@csep.ca

Date: 22 May, 2012

COPYRIGHT PERMISSIONS SUMMARY

Name Author/Publisher	Rob Wilson rwwilson@uwm.edu
Address	n/a
Title of Publication	Development of a Methodology for the Qualification of Physiological Load for Soccer Players
Publication Type	<input type="checkbox"/> Electronic use (eBook, website, app) <input type="checkbox"/> Print use <input type="checkbox"/> College/University Coursepak: <input type="checkbox"/> Electronic <input type="checkbox"/> Print <input checked="" type="checkbox"/> Other (describe): university dissertation

Details of CSEP Work(s) Used	Description	Subject to Fees Yes/No	Acknowledgement Line
CSEP image/cartoon	from Physiological Testing of the Elite Athlete	<input type="checkbox"/> YES <input checked="" type="checkbox"/> NO	-
		<input type="checkbox"/> YES <input type="checkbox"/> NO	-
		<input type="checkbox"/> YES <input type="checkbox"/> NO	-
		<input type="checkbox"/> YES <input type="checkbox"/> NO	-
		<input type="checkbox"/> YES <input type="checkbox"/> NO	-
		<input type="checkbox"/> YES <input type="checkbox"/> NO	-

SUMMARY: Permission granted to use the image referenced in the email dating 26 April, 2012.

NOTES: Please use the following acknowledgement line: '©1982, from Physiological Testing of the Elite Athlete. Used with permission from the Canadian Society for Exercise Physiology.'

Invoice #

LEGEND: Acknowledgement Lines

- Source: *Canadian Physical Activity, Fitness & Lifestyle Approach: CSEP-Health & Fitness Program's Appraisal and Counselling Strategy*, 3rd edition, © 2003. Reprinted with permission from the Canadian Society for Exercise Physiology.
- Source: Physical Activity Readiness Questionnaire (PAR-Q) © 2002. Used with permission from the Canadian Society for Exercise Physiology www.csep.ca.

- 3 Source: Canadian Physical Activity Guidelines, © 2011. Used with permission from the Canadian Society for Exercise Physiology, www.csep.ca/guidelines.
- 4 Source: Canadian Sedentary Behaviour Guidelines for Children and Youth, © 2011. Used with permission from the Canadian Society for Exercise Physiology, www.csep.ca/guidelines.
- 5 Acknowledgement line not required



RightsLink®

- Home
- Create Account
- Help



Title: Modeling human performance in running
Author: R. H. Morton, J. R. Fitz-Clarke, E. W. Banister
Publication: Journal of Applied Physiology
Publisher: The American Physiological Society
Date: Sep 1, 1990
 Copyright © 1990, The American Physiological Society

User ID

 Password

 Enable Auto Login

[Forgot Password/User ID?](#)
If you're a copyright.com user, you can login to Rightslink using your copyright.com credentials. Already a **Rightslink user** or want to [learn more?](#)

Permission Not Required

Permission is not required for this type of use.

- BACK
- CLOSE WINDOW

Copyright © 2012 Copyright Clearance Center, Inc. All Rights Reserved. [Privacy statement.](#) Comments? We would like to hear from you. E-mail us at customer@copyright.com

CURRICULUM VITAE

Robert W. Wilson, II

Place of birth: Louisville, KY

EDUCATION

Bachelor of Arts, Marquette University May 1992

Majors: Broadcasting & Electronic Communications; Philosophy
 Master of Science – Kinesiology, University of Wisconsin–Milwaukee, May 2005
 Focii: Sport and Exercise Physiology, Exercise and Sport Psychology
 Doctor of Philosophy, University of Wisconsin–Milwaukee, August 2012
 Focus: Sport and Exercise Physiology

Dissertation Title: Development of a Methodology for the Quantification of Physiological Load for Soccer Players

MEMBERSHIPS

American Alliance for Health, Physical Education, Recreation and Dance (AAHPERD)
 American College of Sports Medicine (ACSM)
 American College of Sports Medicine – Midwest Regional Chapter (MWACSM)
 American Physiological Society (APS)
 Golden Key International Honor Society
 Human Movement Sciences Graduate Student Association (HMS-GSA) UW–M
 National Soccer Coaches' Association of America (NSCAA)
 National Strength and Conditioning Association (NSCA)
 Professionals in Nutrition for Exercise and Sport (PINES)
 Ultimate Players Association (UPA)

TEACHING EXPERIENCE

Spring 2010 Adjunct Lecturer - Carroll University, Waukesha, WI
 Spring 2007 Adjunct Lecturer - Carroll University, Waukesha, WI

RESEARCH EXPERIENCE

2009 - 2012 Graduate Fellow, Academic Opportunity Program (UW–M)
 2004 - 2012 Human Performance Laboratory (UW–M)
 2007 - 2012 Doctoral student
 2005 - 2007 Research Analyst
 2004 - 2005 Research Assistant and Laboratory Assistant
 2007 - 2008 Healthy Latinos Family Project (UW–M) – Graduate Research Student
 2003 Older Adult Fitness Project – UWM
 7/ 2003 - 12/2003 Graduate Project Assistant
 1/ 2003 - 6/2003 Center Supervisor and Volunteer Assessment Assistant

FUNDING & AWARDS

- 2009 - 2012 Academic Opportunity Program Graduate Fellow
 2012 Student Association Travel Award recipient (UW-M)
 2011 Best Doctoral Student Oral Presentation - Midwest ACSM Annual Meeting
 2010 - 2011 Chancellor's Graduate Student Award (UW-M)
 2010 Graduate School Travel Award recipient (UW-M)
 2009 Graduate School Fellowship (UW-M) – *Offered but not accepted*
 2009 Graduate School Travel Award recipient (UW-M)
 2009 Student Association Travel Award recipient (UW-M)
 2008 College of Health Sciences Student Research Grant Award (UW-M)
 2008 - 2009 Chancellor's Award (UW-M)

CERTIFICATIONS

- Certified Strength and Conditioning Specialist with Distinction (CSCS*D) – National Strength and Conditioning Association (2005 - Present)
 Adult CPR and AED – American Red Cross (6/2004 - Present)
 State Diploma – National Soccer Coaches Association of America (1/2005)
 Coaching Licence – Level Two – Soccer New Zealand (10/1995)
 State "D" License – Illinois State Soccer Coaching School (4/1995)
 Wisconsin Teacher Certification – Wisconsin Department of Public Instruction (1/1995 - 6/2003)

SERVICE

- 2012 Session moderator, American College of Sports Medicine Annual Conference
 2011 - 2012 Abstract reviewer, National Strength and Conditioning Association Annual Conference
 2009 - 2012 Executive Board Member, Soccer and Rugby Special Interest Group
 2009 - 2012 Chaiperson
 2012 - Present Forum moderator
 2007 - 2012 Student member, UW-M Children's Center Review Board
 Subcommittees: Awards (2007 - 2008), Finance (2008 - 2012)
 2004 - Present Athlete Chaperone, United States Anti-Doping Agency
 2009 -2010 Student member, UW-M Athletic Board Committee
 Subcommittees: Long Term Development, Personnel, Academic Integrity
 Appointed for 2010-2011; *not accepted*
 2008 - 2010 Student member, UW-M College of Health Sciences Course and Curriculum Committee